

AIR DISC BRAKE

FIELD MANUAL

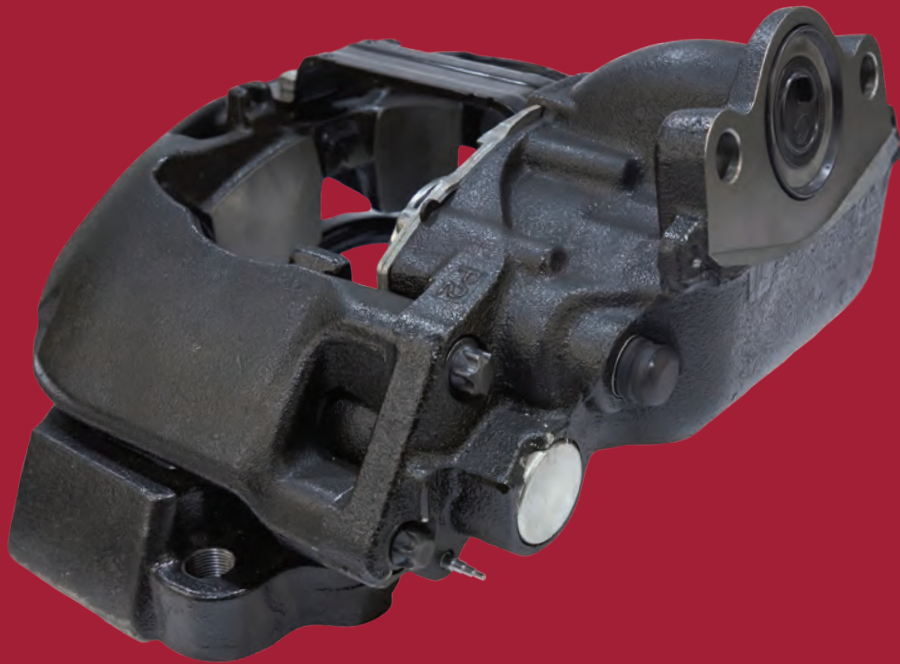

AIR DISC BRAKE CALIPER IDENTIFICATION

STEP 1: Vocation

The tabbed sections are arranged by application. Choose the section that corresponds with the application of your vehicle.



TRUCK



TRAILER



BUS & SPECIALTY

STEP 2: Brake Pads

Identify the caliper manufacturer by pad length and shape—paying particular attention to the top edge. Match up the retainer bar as well to narrow down your search.

IDENTIFY PAD BY LENGTH AND SHAPE



STEP 3: Axial vs Radial Mount Calipers

Once you know the caliper type, you need to identify the pad carrier mount.

- **Axial** – a mounting surface that is parallel to the rotor
- **Radial (also known as vertical)** – a mounting surface that is perpendicular (90°) to the rotor

Some calipers have a radially mounted air chamber. If your caliper has a radial chamber (sits on top of the caliper) and is not on a transit bus, please refer to PB-1461.

AXIAL MOUNT



RADIAL MOUNT



STEP 4: Left Hand vs. Right Hand Calipers

Calipers have a long and short slide pin, and their location describes if they are left or right. In most cases, a left caliper will be used on the driver's side of the vehicle. There are some exceptions where interference in the wheel well prevents this. Make sure you replace a left with a left and right with a right.

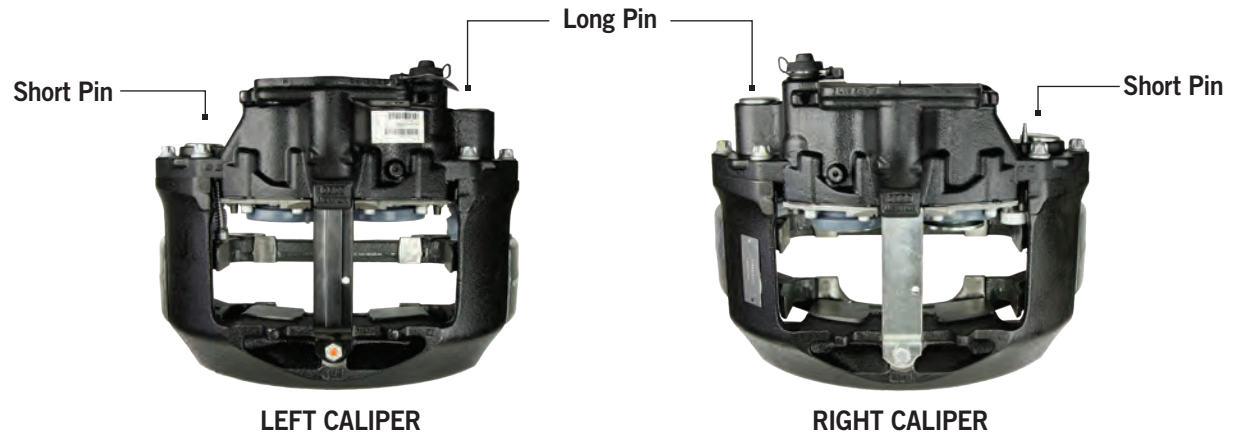

Rotors

This field manual provides the proper Meritor rotor part numbers for each caliper.



Hardware Kits

This field manual identifies two common kits:

- **Slide Pin Kits:** a complete kit that includes slide pins, bushings, boots, bolts, caps and grease—everything you need for a slide pin replacement.
- **Boot Kit:** also known as a tappet boot kit or clamping unit, includes replacement boots, grease and other parts (varies by caliper manufacturer).



This field manual does not cover all possible calipers. If you can't find what you are looking for, refer to MeritorPartsXpress.com or PB-1461.

CONCERNED ABOUT LOSING YOUR ADB22X™ WARRANTY?

When it comes to caliper protection,
we've got you covered.

When you choose Meritor® MMD1369AG air disc brake pads, you have peace of mind knowing that not only do you have high-quality, long-lasting pads on your vehicle, but you will also be covered if there is a caliper failure. That's right. If you use Meritor pads and your Bendix® ADB22X™ fails within its warranty period we will replace it with a Meritor® remanufactured caliper. (See SP-2207 for details.)



**COMPLETE
SUPPORT**
AND CUSTOMER CARE

LINE HAUL 
AND SPECIALTY APPLICATIONS



**REDUCED-COPPER
COMPLIANT**

TRUCK CALIPERS



TRUCK CALIPER IDENTIFICATION CHART						
Suspension	Bolt Pattern	# of Holes	Bolt Diameter	A-B Distance (in.)	Type	Page
NAFTA® Mount		6	M20	2 9/16"	Bendix® ADB22X	10
					WABCO® Maxxus	12
					Meritor® Twin	8
					Meritor® Single	6
Freightliner® Radial		6	M16	2"	Bendix® ADB22X	10
		4	M20	1 3/4"	WABCO® Maxxus	12
Volvo® Axial		6	M20	2 15/16"	Meritor® Twin	8
Volvo® Radial		4	M20	1 9/16"	Meritor® Twin	8

MERITOR® SINGLE PISTON

Axial Mount Caliper

RIGHT CALIPER PART #: EX225S204XX000

LEFT CALIPER PART #: EX225S203XX000



MERITOR® AXLE ROTORS

Meritor Part #	Type	OD (mm)	Height	Notes
M44DH83923	Flat	430	45	Front with press on tone ring
M44DH83924	Flat	430	45	Rear with bolt on tone ring

HARDWARE KITS

Description	Meritor Part #
Complete Slide Pin Kit	KIT225303
Boot Kit	KIT225302

Air Disc Brake Pads

with Hardware



LINE HAUL BRAKE PAD
PART #: KIT2252L2CG2

Includes 6 pad springs



MERITOR® EX225L TWIN PISTON

Axial Mount Caliper

Found on Meritor® Axles

RIGHT CALIPER PART #: EX225L262XX000

Remanufactured: EX225L262R

LEFT CALIPER PART #: EX225L261XX000

Remanufactured: EX225L261R



Axial Mount Caliper

Volvo® Trucks with Volvo® Group Steer Axles

RIGHT CALIPER PART #: EX225L266XX000

LEFT CALIPER PART #: EX225L265XX000

Radial Mount Caliper

Volvo® Trucks with Volvo® Group Drive Axles

RIGHT CALIPER PART #: EX225L270XX000

LEFT CALIPER PART #: EX225L269XX000

MERITOR® AXLE ROTORS

Meritor Part #	# of Mounting Holes	OD (mm)	Notes	Application
M44DH83923	10	430	Front, press on tone ring	Axial mount
M44DH83924	10	430	Rear, bolt on tone ring	Axial mount

HARDWARE KITS

Description	Meritor Part #
Complete Slide Pin Kit*	KIT225277
Boot Kit	KIT225282

*Slide Pin Kit works on all EX+L calipers except EX225L201-211 and EX225L245-246

Air Disc Brake Pads with hardware



LINE HAUL BRAKE PAD PART #: KIT2252L2CG

Genuine pad kit used in all Meritor® EX22L calipers in line haul applications

LINE HAUL BRAKE PAD PART #: KIT2252LCM7400

Genuine pad kit used in Volvo®/Mack® calipers in line haul applications



SEVERE SERVICE BRAKE PAD PART #: KIT2252L2DD

Severe Service pad kit for Meritor® EX225L calipers



BENDIX® ADB22X

Axial Mount Caliper

Found on Paccar®, Navistar®, Freightliner®

RIGHT CALIPER PART #: MK081142X

OE REF: K081142, K097850SC, K147430X, K109961X

LEFT CALIPER PART #: MK081143X

OE REF: K081143, K097851SC, K147431X, K109962X

UPGRADE NOW!
KIT225295

SEE PAGE 37 FOR DETAILS

Radial Mount Caliper

Found on Freightliner® with Detroit Axle

**RIGHT CALIPER PART #:
MK081256X**

OE REF: K081256, K097846SC,
K109957X, K147136X

**LEFT CALIPER PART #:
MK081257X**

OE REF: K081257, K097847SC,
K109958X, K147135X

UPGRADE NOW!
KIT225296

SEE PAGE 37 FOR DETAILS



MERITOR® AXLE ROTORS				
Meritor Part #	# of Mounting Holes	OD (mm)	Depth	Application
M44DH802569	Splined	430	45	Axial Mount
M44D802082	10	430	150	Axial Mount
M44D802081	10	430	138	Axial Mount
M44DH20682	10	430	160	Radial Mount

HARDWARE KITS	
Description	Meritor Part #
Complete Slide Pin Kit	MCKSK.6.2
Boot Kit	MCKSK.4.2

Air Disc Brake Pads with Hardware



LINE HAUL BRAKE PAD PART #: MMD1369AG

Replaces OE: K070796, K129276,
K182235, S-29152-2



SEVERE SERVICE BRAKE PAD PART #: MMD1369DD

Replaces OE: K109113

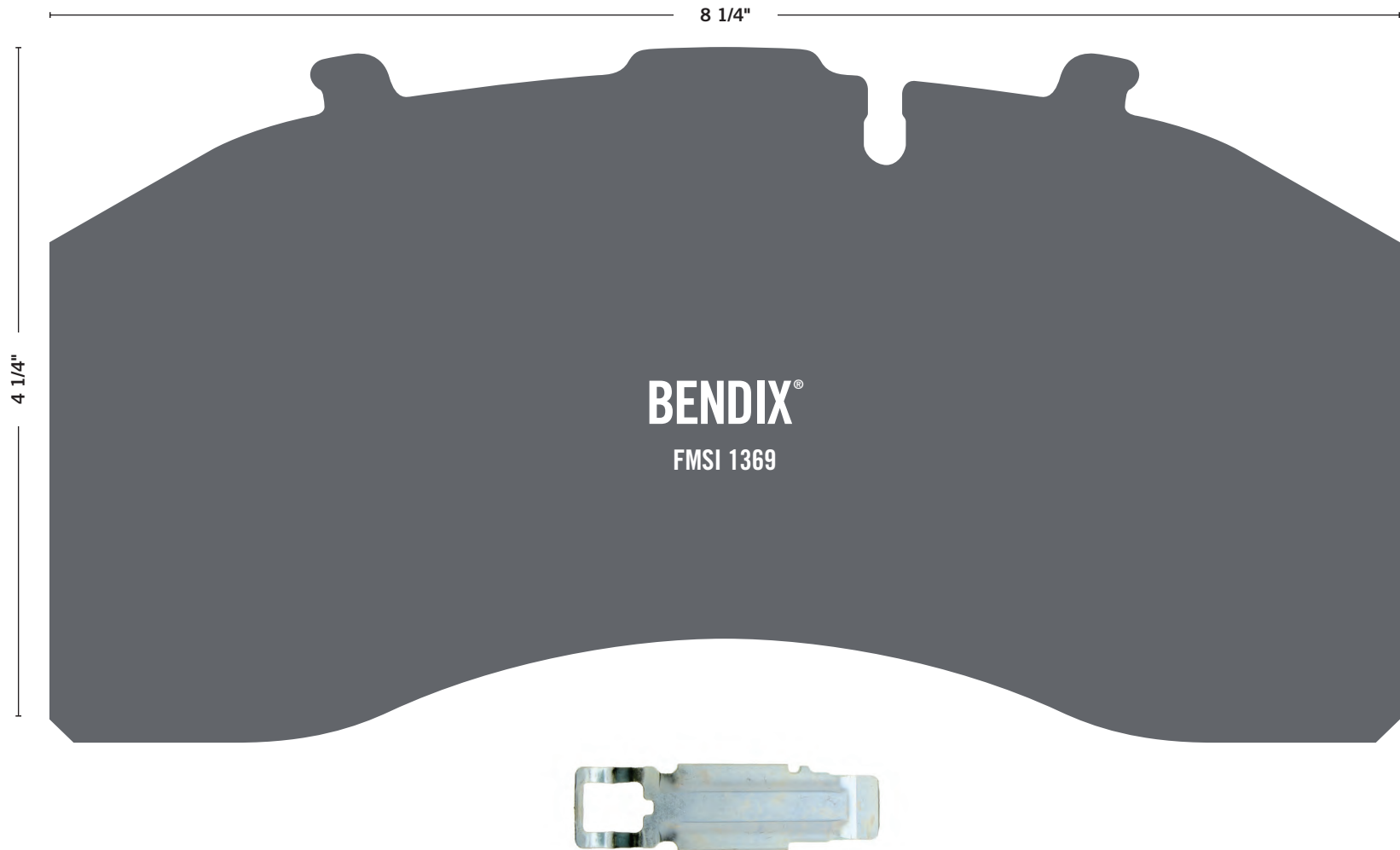

WABCO® MAXXUS

Radial Mount Caliper

Found on Freightliner® with Detroit Axles

RIGHT CALIPER PART #: 640 322 066 ONX

OE REF: 640 322 051 0

LEFT CALIPER PART #: 640 322 065 ONX

OE REF: 640 322 050 0

UPGRADE NOW!
KIT225298

SEE PAGE 37 FOR DETAILS



MERITOR® AXLE ROTORS

Meritor Part #	# of Mounting Holes	OD (mm)	Depth	Application
M44DH20682	10	430	160	Radial Mount

HARDWARE KITS

Description	Meritor Part #
Complete Slide Pin Kit	640 322 938 2
Boot Kit	640 322 932 2

Not a replacement for WABCO® Maxxus 2.0

**Air Disc
Brake Pads**
with Hardware



LINE HAUL BRAKE PAD
PART #: MMD2061AG
Replaces OE: 640 322 934 2



REPLACEMENT AIR DISC BRAKE PARTS? YOU HAVE A CHOICE.

Meritor® air disc brake pads are engineered to provide an enhanced solution with the performance required when replacing original equipment products. Meritor ADB friction meets strict Meritor quality standards for stopping distance, low maintenance, downtime costs and lasting value.



MA9300 & MH9310
FRICITION 
 **LINE HAUL &
TRANSIT/BUS**

 **MA9500
FRICITION
REFUSE/SPECIALTY**

TRAILER CALIPERS



TRAILER CALIPER IDENTIFICATION CHART

Suspension	Bolt Pattern	Bolt Diameter	A-B Distance (in.)	Type	Page
Hendrickson® / Meritor®		M20	3 1/4"	Bendix® ADB22X	20
				WABCO® Pan 22	22
				Meritor® Twin	18
Meritor® Truck Mount		M20	2 9/16"	Meritor® Single	16
Hendrickson® MAXX22		M18	1 3/4"	WABCO® MAXX 22T	24
SAF-Holland®		M18	2"	Bendix® SK7	26
Ridewell Reyco® / AXN / IMT		M16	4 1/8"	WABCO® Pan 22	22
IMT		M14	2"	WABCO® Pan 17	28

MERITOR® SINGLE PISTON

Axial Mount Caliper

RIGHT CALIPER PART #: EX225S204XX000

LEFT CALIPER PART #: EX225S203XX000



MERITOR® AXLE ROTORS

Meritor Part #	Type	OD (mm)	Height	Notes
M44D802082	U-shape	430	150	
M44DHS34172006	U-shape	430	150	Includes tone ring
M44DH18609	Flat	430	45	

HARDWARE KITS

Description	Meritor Part #
Complete Slide Pin Kit*	KIT225303
Boot Kit	KIT225302

Air Disc Brake Pads

with Hardware



LINE HAUL BRAKE PAD
PART #: KIT2252L2CG2

Includes 6 pad springs

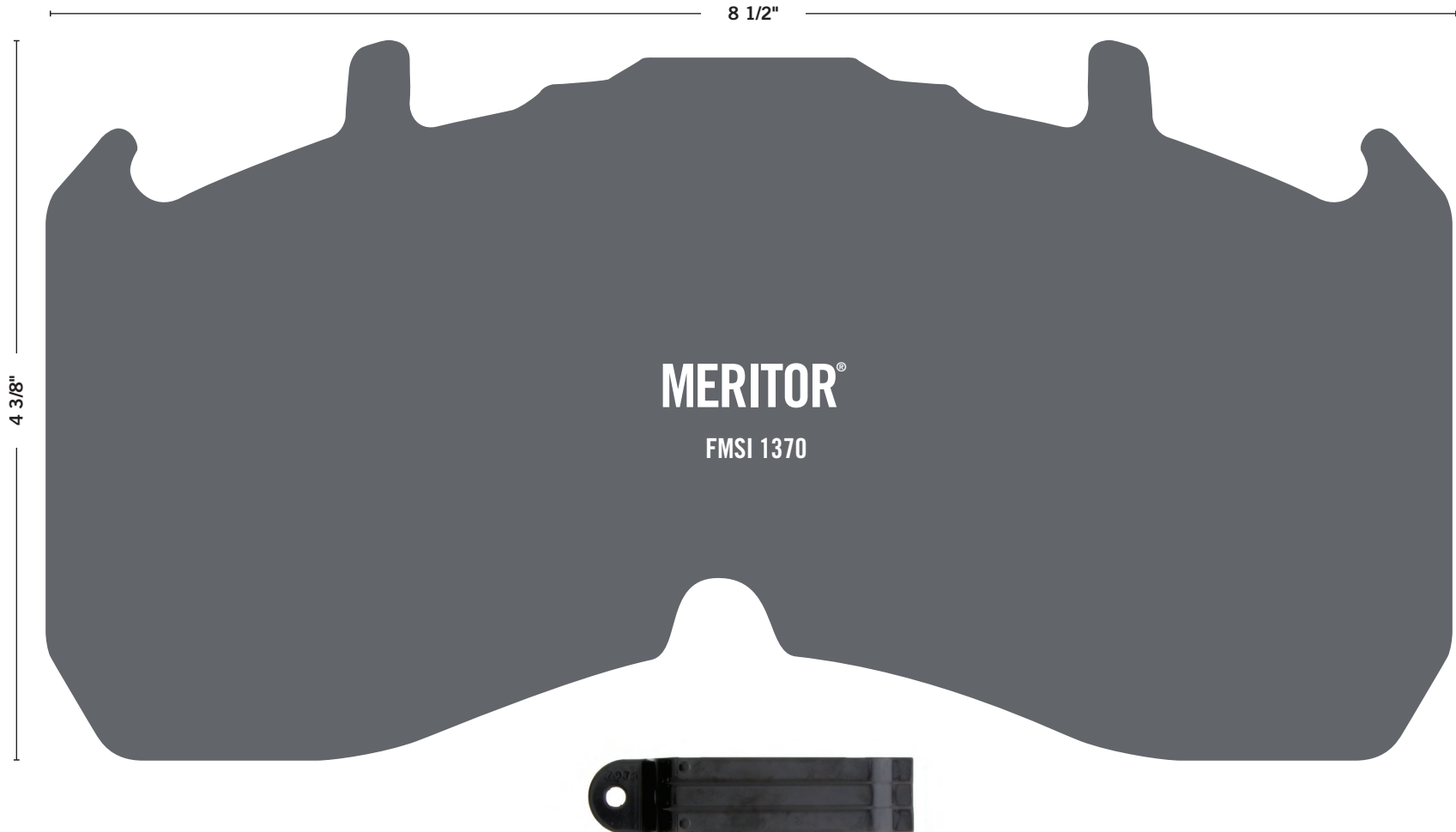

MERITOR® EX225L TWIN PISTON

Axial Mount Caliper

Found on Meritor® Trailer Axles

RIGHT CALIPER PART #: EX225L272XX000

Remanufactured: EX225L258R

LEFT CALIPER PART #: EX225L271XX000

Remanufactured: EX225L257R



MERITOR® AXLE ROTORS

Meritor Part #	# of Mounting Holes	OD (mm)	Depth	Notes
M44DH802082	10	430	150	No tone ring
M44DHS34172006	10	430	150	Includes bolt on tone ring

HARDWARE KITS

Description	Meritor Part #
Complete Slide Pin Kit*	KIT225277
Boot Kit	KIT225282

*Slide Pin Kit works on all EX+L calipers except EX225L201-211 and EX225L245-246

Air Disc Brake Pads with Hardware



LINE HAUL BRAKE PAD PART #: KIT2252L2CG

Genuine Pad kit used in all Meritor® EX22L calipers in line haul applications



SEVERE SERVICE BRAKE PAD PART #: KIT2252L2DD

Severe Service pad kit for Meritor® EX225L calipers



BENDIX® ADB22X

Axial Mount Caliper

Found on Hendrickson®, Intraxx®, Meritor®, etc.

RIGHT CALIPER PART #: M802984X

OE REF: 802984, K113887X, K149714

LEFT CALIPER PART #: M802985X

OE REF: 802985, K113888, K149715

UPGRADE NOW!
KIT225222

SEE PAGE 37 FOR DETAILS



MERITOR® AXLE ROTORS

Meritor Part #	# of Mounting Holes	OD (mm)	Depth	Notes
M44DH802569	Splined	430		
M44D802082	10	430	150	No tone ring
M44DHS34172006	10	430	150	Comes w/ tone ring
M44DH18609	10	430	45	

HARDWARE KITS

Description	Meritor Part #
Complete Slide Pin Kit	MCKSK.6.2
Boot Kit	MCKSK.4.2

Air Disc Brake Pads with Hardware



LINE HAUL BRAKE PAD PART #: MMD1369AG

Replaces OE: K070796, K129276,
K182235, S-29152-2



SEVERE SERVICE BRAKE PAD PART #: MMD1369DD

Replaces OE: K109113

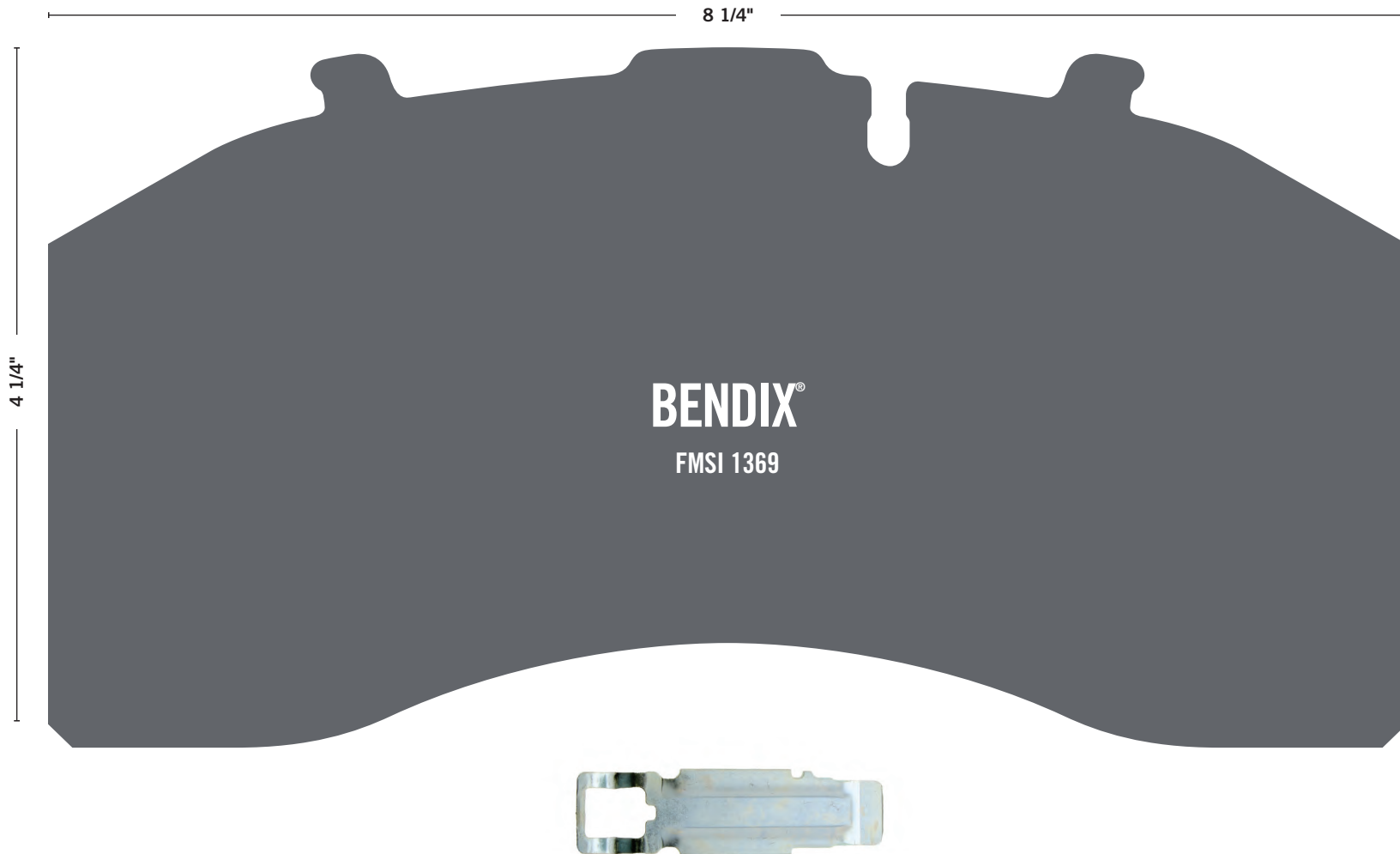

WABCO® PAN 22

Axial Mount Caliper

Found on Hendrickson®, Intraxx®, Meritor® Axles

RIGHT CALIPER PART #: 640 225 081 ONX

OE REF: 640 225 037 0, 640 225 145 0

LEFT CALIPER PART #: 640 225 080 ONX

OE REF: 640 225 036 0, 640 225 144 0

UPGRADE NOW!
KIT225222

SEE PAGE 37 FOR DETAILS

Axial Mount Caliper

Found on Ridewell®, Reyco Granning®,
AXN®, IMT®

RIGHT CALIPER PART #: 40 225 016NX

OE REF: 40 225 012, 40 225 016, 640 225 147 0

LEFT CALIPER PART #: 40 225 015NX

OE REF: 40 225 011, 40 225 015, 640 225 146 0



MERITOR® AXLE ROTORS				
Meritor Part #	# of Mounting Holes	OD (mm)	Depth	Notes
M44DH802569	Splined	430		
M44D802082	10	430	150	No tone ring
M44DHS34172006	10	430	150	Comes with tone ring
M44DH18609	10	430	45	

HARDWARE KITS	
Description	Meritor Part #
Complete Slide Pin Kit	640 225 921 2
Boot Kit	640 175 920 2

Air Disc Brake Pads

with Hardware



LINE HAUL BRAKE PAD PART #: MMD1777AG

Replaces OE: 12 999 796, 640 225 922 2,
640 225 938 2



HENDRICKSON MAXX22T™

Axial Mount Caliper

RIGHT CALIPER PART #: 640 222 008 ONX

OE REF: 640 222 006 0

LEFT CALIPER PART #: 640 222 007 ONX

OE REF: 640 222 005 0



MERITOR® AXLE ROTORS

Meritor Part #	# of Mounting Holes	OD (mm)	Depth	Notes
M44DHS34471	10	415	150	Standard Hub

HARDWARE KITS

Description	Meritor Part #
Complete Slide Pin Kit	640 222 928 2
Boot Kit	640 175 920 2

Air Disc Brake Pads

with Hardware



LINE HAUL BRAKE PAD
PART #: MMD1777M22TAG

Replaces OE: 640 222 938 2



SAF-HOLLAND® SK7

Axial Mount Caliper

C88 / P89 Integral Disc

RIGHT CALIPER PART #: MK110226X

OE REF: 3080 00 5901, 3080 00 5921, K110226

LEFT CALIPER PART #: MK110227X

OE REF: 3080 00 6001, 3080 00 6021, K110227

HARDWARE KITS

Description	Meritor Part #
Complete Slide Pin Kit	MCKSK.6.2
Boot Kit	MCKSK.4.2



Air Disc Brake Pads

with Hardware



LINE HAUL BRAKE PAD
PART #: MMD1369SAF

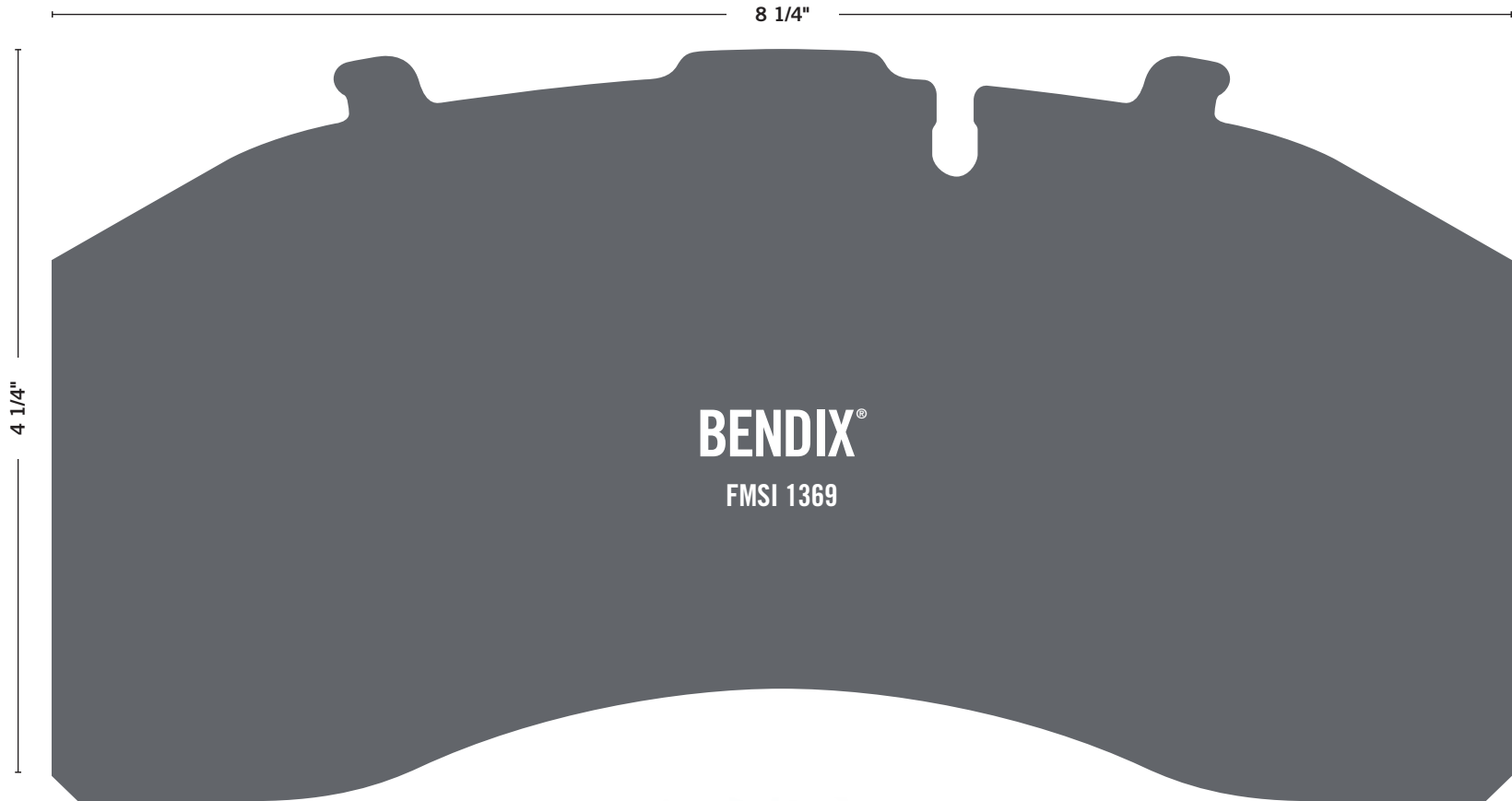

WABCO® PAN 17

Axial Mount Caliper

RIGHT CALIPER

PART #: 40 175 073NX

OE REF: 40 175 091

LEFT CALIPER

PART #: 40 175 072NX

OE REF: 40 175 090



MERITOR® AXLE ROTORS

Meritor Part #	# of Mounting Holes	OD (mm)	Depth (mm)
M44D75180	8	325	149

HARDWARE KITS

Description	Meritor Part #
Complete Slide Pin Kit	12 999 699VT
Boot Kit	640 175 920 2

Air Disc Brake Pads with Hardware



TRAILER BRAKE PAD
PART #: MMD1518AG

Replaces OE: 12 999 806, 640 175 952 2

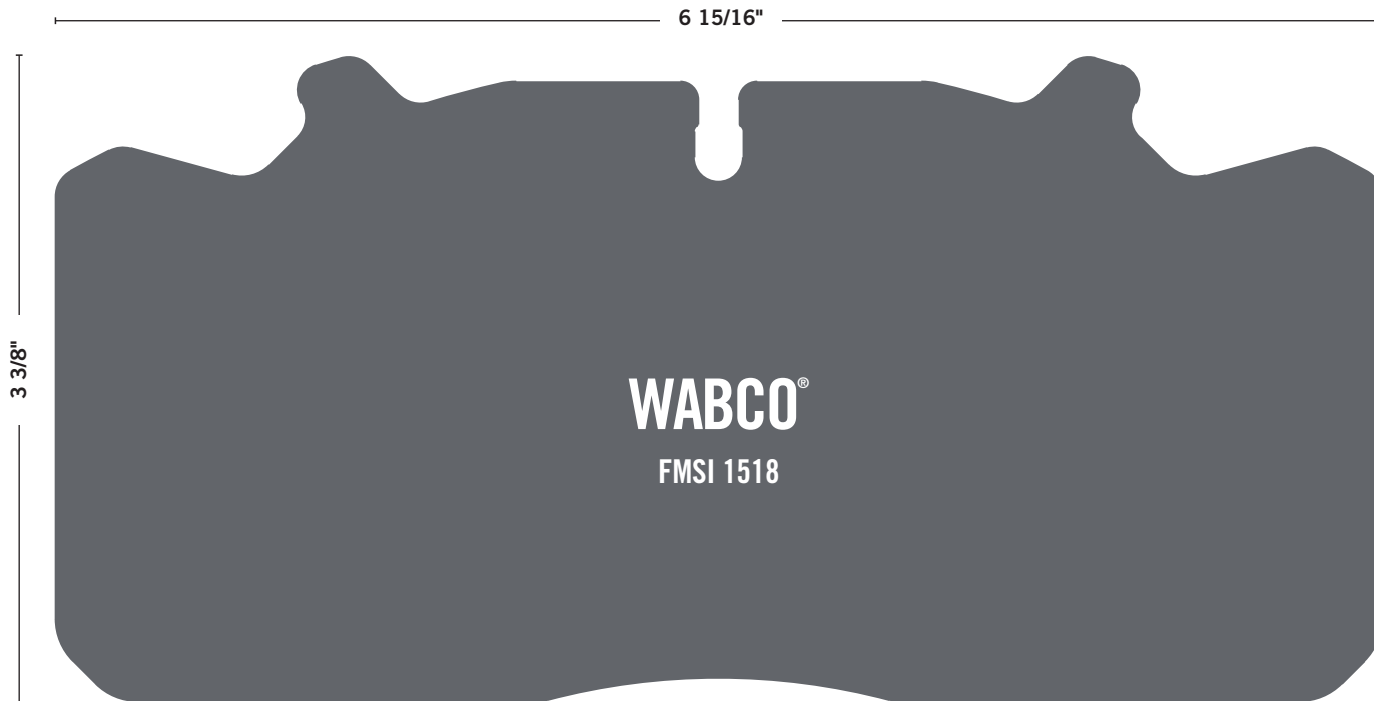

WHATEVER YOUR RIDE, THIS IS YOUR STOP.

A trusted name for heavy-duty braking now offers aftermarket air disc brake rotors for all-makes. Engineered and tested for reliable performance, these rotors offer durability, long friction life and excellent fade resistance. As part of our comprehensive air disc brake portfolio, they make it possible to standardize your air disc brake service needs with confidence.

MeritorPartsXpress.com



**COMPREHENSIVE
PORTFOLIO**



1 YEAR



BUS & SPECIALTY CALIPERS



TRAILER CALIPER IDENTIFICATION CHART

Suspension	Bolt Pattern	# of Holes	Bolt Diameter	A-B Distance (in.)	Type	Page
Meritor® Specialty Axles		6	M20	4 1/8"	Refuse	32
					Transit	32
Volvo / Mack®		6	M20	2 15/16"	Volvo Axial	32
		4		1 9/16"	Volvo Radial	32
New Flyer Xcelsior®		6	M18	4 1/8"	Front / Rear	34
Nova LFS Radial Chamber		6	M16	1 5/8"	Rear / Center (Nova and NF)	34
Nova LFS		4	M20	2 11/16"	Front	34

MERITOR® EX225H

Axial Mount Caliper

Found on Meritor® Axles Used in Refuse and Transit Applications

RIGHT CALIPER (Refuse Truck)

PART #: EX225H201XX000

Remanufactured version: EX225H201R

LEFT CALIPER (Refuse Truck)

PART #: EX225H202XX000

Remanufactured version: EX225H202R

RIGHT CALIPER (Transit)

PART #: EX225H301XX000

Remanufactured version: EX225H301R

LEFT CALIPER (Transit)

PART #: EX225H302XX000

Remanufactured version: EX225H302R



Axial Mount Caliper

Found on Volvo® Refuse Trucks with Volvo® Group Steer Axles

RIGHT CALIPER PART #: EX225H228XX101

Remanufactured version: EX225H218R

LEFT CALIPER PART #: EX225H227XX101

Remanufactured version: EX225H217R

Radial Mount Caliper

Found on Volvo® Refuse Trucks with Volvo® Group Drive Axles

RIGHT CALIPER PART #: EX225H226XX101

Remanufactured version: EX225H216R

LEFT CALIPER PART #: EX225H225XX101

Remanufactured version: EX225H215R

MERITOR® AXLE ROTORS					
Meritor Part #	# of Mounting Holes	OD (mm)	Height (mm)	Notes	Application
23 123642 015	10	434	131	Refuse Truck	Axial Mount
23 123647 002	10	434	143	Transit Bus	Axial Mount

HARDWARE KITS	
Description	Meritor Part #
Complete Slide Pin Kit	KIT225280
Boot Kit	KIT225201

Air Disc Brake Pads with Hardware



TRANSIT BRAKE PAD PART #: KIT2252H2CG

Pad kit used in all Meritor® EX22H calipers
for transit applications



SEVERE SERVICE BRAKE PAD PART #: KIT2252H2DD

Pad kit for Meritor® EX225H calipers
for refuse/severe service applications

PART #: KIT2252HBMA9500

Pad kit used in Volvo®/Mack® calipers
for refuse/severe service applications

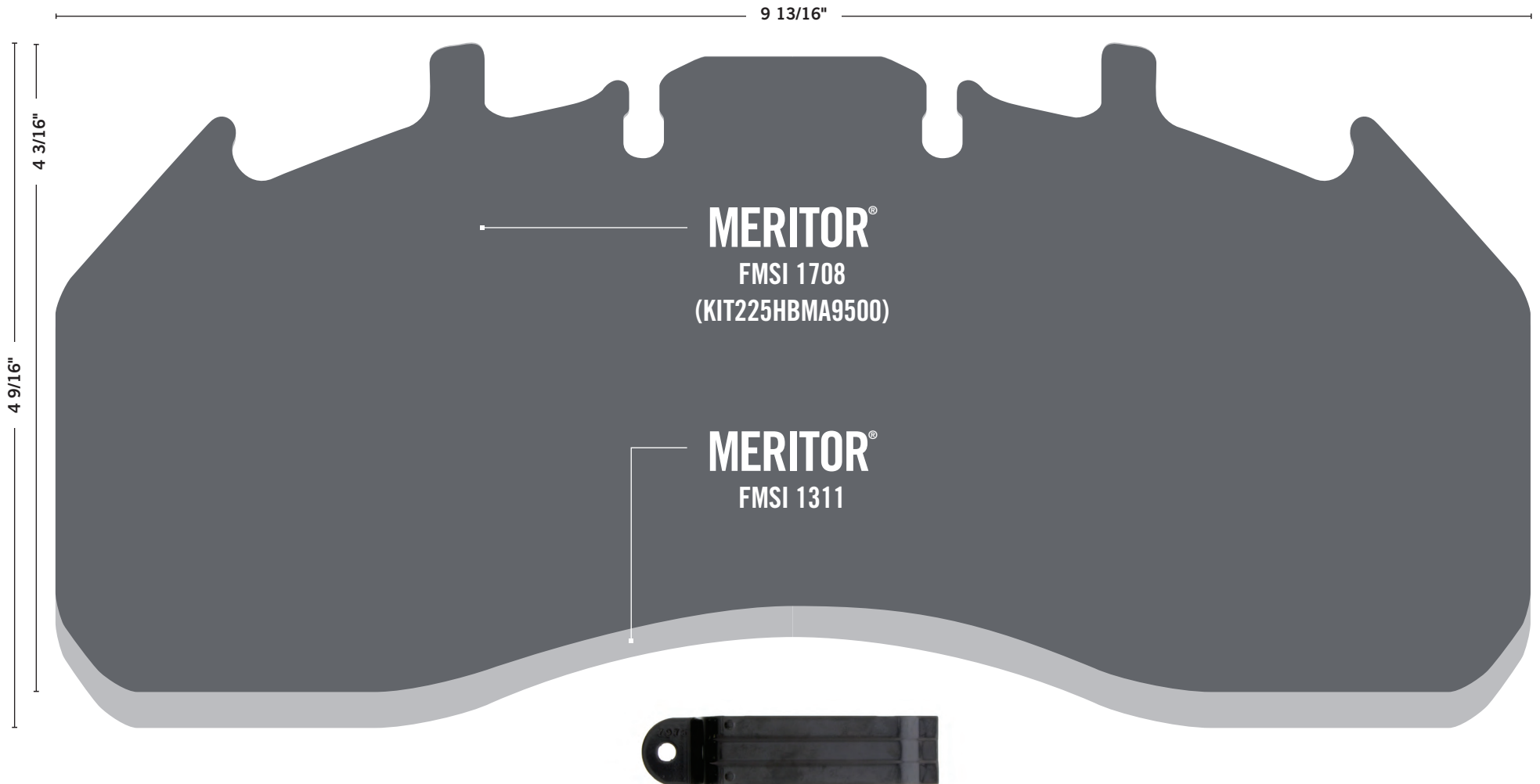

BENDIX® SN7/SB7

New Flyer Xcelsior

RIGHT CALIPER (front left, rear right)
PART #: MK100093X

OE REF: K100093, 6447272, 81.50804.6652

LEFT CALIPER (front right, rear left)
PART #: MK100094X

OE REF: K100094, 6447270, 81.50804.6651

UPGRADE NOW!
KIT225290FRT, KIT225290RR

SEE PAGE 37 FOR DETAILS

NEW FLYER XCELSIOR ROTORS				
Meritor Part #	# of Mounting Holes	OD (mm)	Depth	Rotor
MBR5057	12	432	130	Front
MBR5068	10	432	135	Rear

Nova LFS Drive

RIGHT CALIPER PART #: MK021989X
 OE REF: 6447850, 0501 008 593, K064525

LEFT CALIPER PART #: MK021990X
 OE REF: 6447849, 0501 008 594, K064526

UPGRADE NOW!
KIT225291CF

SEE PAGE 37 FOR DETAILS

NOVA (ALL), NF XCELSIOR CENTER ROTOR			
Meritor Part #	# of Mounting Holes	OD (mm)	Depth
M44DK021958	10	430	131

HARDWARE KITS	
Description	Meritor Part #
Complete Slide Pin Kit	MCKSK.3.2
Boot Kit	MCKSK.4.2

Nova LFS Front

RIGHT CALIPER PART #: MK021991X
 OE REF: K108187, K064529, 0501.008.892, N8900425

LEFT CALIPER PART #: MK021992X
 OE REF: K108188, K064530, 0501.008.893, N8893344

UPGRADE NOW!
KIT225292CF

SEE PAGE 37 FOR DETAILS



**Air Disc
Brake Pads**
with Hardware



**TRANSIT BRAKE PAD
PART #: MMD1203AG**

Replaces OE: N8893343, 0501.215.084,
6447341, 81.50820.6083, K046771K50



**SEVERE SERVICE BRAKE PAD
PART #: MMD1203DD**

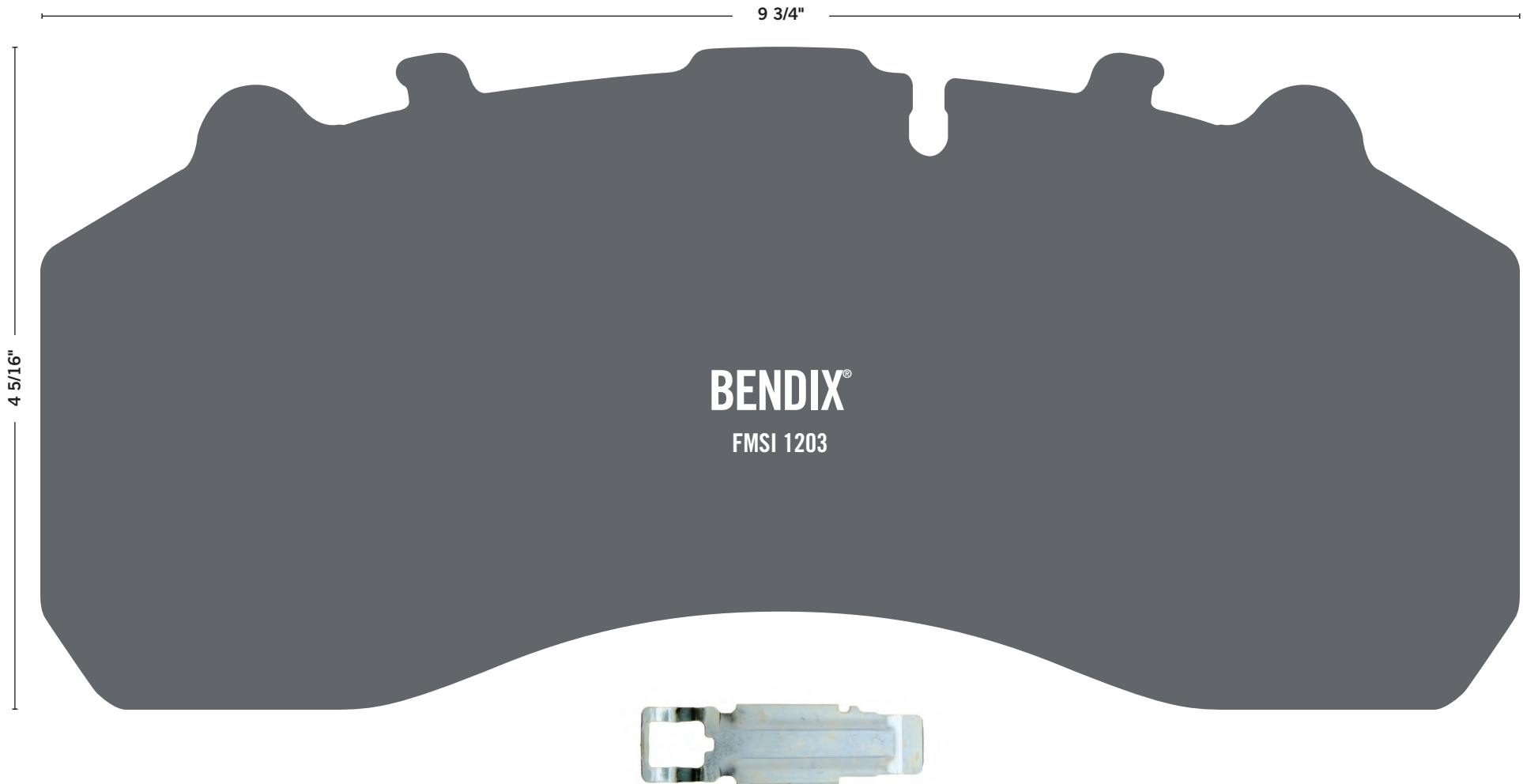

MERITOR® AIR DISC BRAKE CALIPER UPGRADE KITS

THE RIGHT BRAKE TO KEEP YOU ON YOUR JOURNEY.

SEALED HOUSING DESIGN



PROVIDES PROTECTION FROM WATER AND HELPS PREVENTS CONTAMINATION

FEATURING BOLT-ON REPLACEMENT



SO YOU ONLY CHANGE THE CALIPERS AND PADS



5-YEAR WARRANTY

FOR ON-ROAD APPLICATIONS

CALIPER UPGRADE KITS

TRUCK

Part Number	Application	Replaces OEM Part Numbers
KIT225295	Bendix® Axial Mount	K081142, K081143, K097850SC, K097851SC
KIT225296	Bendix® Radial Mount	K081256, K081257, K097846SC, K097847SC
KIT225298	WABCO® Radial Mount	640 322 065 0, 640 322 066 0

TRAILER

Part Number	Application	Replaces OEM Part Numbers
KIT225222	Hendrickson INTRAXX® AAT, AANT	Bendix® K149714, K149715, 802984, 802985 / WABCO® 640 225 080 0, 640 225 081 0
KIT225299	Hendrickson® Maxx22T	COMING SOON

TRANSIT AND COACH

Part Number	Application	Replaces OEM Part Numbers
KIT225290CF	New Flyer Xcelsior®, MAN Axle	6447269, 6447270, 6447271, 6447272, 6361223, 6361224
KIT225291CF	Nova® Rear, Nova® and New Flyer® Center, ZF Axle	K064252, K064526, K138983, K138984, 6429512, 6429515, 6447849, 6447850
KIT225292CF	Nova® Front, ZF Axle	N8900425, N8900426, 0501.008.892, 0501.008.893
KIT225293	Van Hool®, MAN Axle	K015013, K015014, 80.50804.6617
KIT225294	MCI® J-Coach	K082530, K082631, K082532, K082533



Vehicle models, trademarks, brands, and names depicted herein are the property of their respective owners, and may not be associated with Cummins Inc. and Meritor, Inc. or its affiliates.



Cummins Inc.
Box 3005
Columbus, IN 47202-3005
U.S.A.

cummins.com | MeritorPartsXpress.com

SP-2316
Bulletin 6484443 Produced in U.S.A. Rev. 2/24
©2024 Meritor, Inc.