

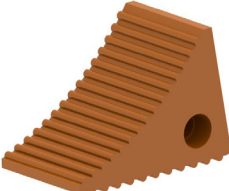

# GAFF® POLYURETHANE COMPONENTS FOR ACCESSORY COMPONENTS

Wheel Chock - Various	
	
PART NO.	NOTES/INCLUDES
<b>GAFF18455</b>	Length 8 11/16", Width 5 1/2", Height 6 5/16"

Hood Latch Kit - Peterbilt & Kenworth	
OEM: L56-0001 23-13857 L03-0001 17-14781-000	
	
PART NO.	NOTES/INCLUDES
<b>GAFF11851</b>	2 per Truck; Includes 1 -GAFF11097 Hood hook, 1 -GAFF11134 Latch Assy 4.271" - 9.05" overall, includes metal bracket

Hood Latch Assembly - Freightliner	
OEM: 680-880-01-60 L56-0001	
	
PART NO.	NOTES/INCLUDES
<b>GAFF11103</b>	Includes pivot bracket

Wheel Chock - Various	
	
PART NO.	NOTES/INCLUDES
<b>GAFF40095</b>	Length 12 1/8", Width 8 3/8", Height 7 3/4"

Hood Latch Kit - Freightliner	
OEM: 17-12438-000 17-12434-000	
	
PART NO.	NOTES/INCLUDES
<b>GAFF11185</b>	2 per Truck; Includes 1 -GAFF 11096 Hood hook, 1 -GAFF11176 Latch Assy 6.041" - 10.93" overall, includes metal bracket

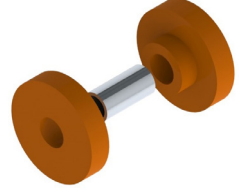
Radiator Mount - Freightliner	
OEM: 05-160-70-000	
	
PART NO.	NOTES/INCLUDES
<b>GAFF11021</b>	OD 3", ID 7/8", Length 1-13/16"

Shifter Bushing Kit - Eaton® Transmissions	
OEM: 85105720	
	
PART NO.	NOTES/INCLUDES
<b>GAFF11611</b>	Bushing, 2 Spacers, Bolt, Nut

Hood Latch - Freightliner	
OEM: 680-880-01-60 L56-0001	
	
PART NO.	NOTES/INCLUDES
<b>GAFF12365</b>	Latch 3.76" - 8.89" overall

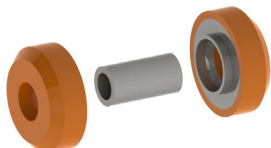
Vibration Mount - Reefer	
OEM: 91-1404 91-2578 91-7709	
	
PART NO.	NOTES/INCLUDES
<b>GAFF50056</b>	Includes: lower and upper bushing with spacer, OD 2 1/2", ID 5/8", Height 1 3/4"

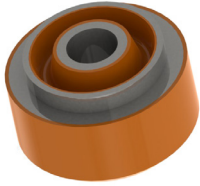
Vibration Mount - Reefer	
OEM: 91-2618 91-4159 	
PART NO.	NOTES/INCLUDES
<b>GAFF12380</b>	OD 2-5/16", ID 11/16", Height 1-7/16"

Glad Hand Seal - Various	
	
PART NO.	NOTES/INCLUDES
<b>GAFF17674</b>	OD 1-5/8", ID 11/16"

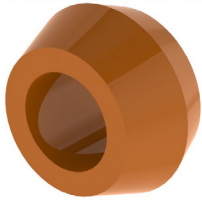
Shock Absorber Bushing - Various	
	
PART NO.	NOTES/INCLUDES
<b>GAFF30545</b>	OD 1-15/16", ID 1", 1-3/32"

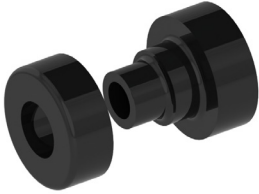
Exhaust Mount - Peterbilt & Kenworth	
OEM: 14-14656 14-B656 	
PART NO.	NOTES/INCLUDES
<b>GAFF12357</b>	Includes 1 Upper Mount & 1 Lower Mount

Glad Hand Seal - Various	
	
PART NO.	NOTES/INCLUDES
<b>GAFF17675</b>	OD 1-5/8", ID 11/16"

Fifth Wheel Bushing - SAF-HOLLAND	
OEM: XB-0011-2 	
PART NO.	NOTES/INCLUDES
<b>GAFF11517</b>	ID 1-1/8", Length 4-1/4", Height 2-11/32"; Use GAFF40140 for the complete replacement kit

Exhaust Mount Kit - Peterbilt & Kenworth	
OEM: M13-6001 M13-1009 CB-2203-73 	
PART NO.	NOTES/INCLUDES
<b>GAFF11811</b>	1 Bushing Kit -GAFF11810, 1 Mount -GAFF11809

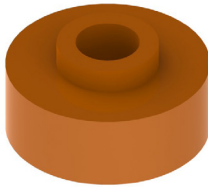
Shock Absorber Bushing - Peterbilt & Kenworth	
OEM: CA368-6 COM266 COM368-6 K066-266 	
PART NO.	NOTES/INCLUDES
<b>GAFF11550</b>	OD 2", ID 5/8", Length 1"

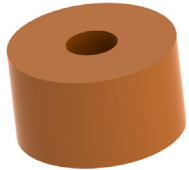
Fifth Wheel Bushing - Fontaine®	
OEM: BSH-150 	
PART NO.	NOTES/INCLUDES
<b>GAFF10002</b>	OD 4", ID 1-1/4", Length 2-1/4"; Use GAFF40141 for the complete replacement kit

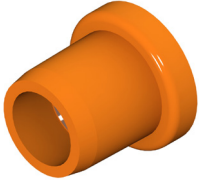
Air Cooler Mount - Various	
OEM: M200 M200-70EP 13-01633 	
PART NO.	NOTES/INCLUDES
<b>GAFF11554</b>	Length 1", OD 1"

Shock Absorber Bushing - Various	
	
PART NO.	NOTES/INCLUDES
<b>GAFF30507</b>	OD 1-29/32", ID 1", Length 15/16"

Fifth Wheel Bushing - SAF-HOLLAND	
OEM: SAFXB10605 	
PART NO.	NOTES/INCLUDES
<b>GAFF40035</b>	OD 2-9/16", ID 1-1/18", Length 2-1/8"; Includes two bushings

For best durability and performance, GAFF® Polyurethane should not be mixed with other manufacturers' polyurethane or rubber products when replacing components.

Vehicle models, trademarks, brands, and names depicted herein are the property of their respective owners, and may not be associated with Meritor, Inc. or its affiliates.



Meritor Heavy Vehicle Systems, LLC  
 7975 Dixie Highway  
 Florence, Kentucky 41042 USA

888-725-9355 U.S.  
 800-387-3889 Canada  
 MeritorPartsXpress.com  
 meritor.com

©2021 Meritor, Inc.  
 Litho in USA, SP-2199  
 Issued 05-21 (FLOA)