





Hendrickson Suspension Torque Rod Assemblies

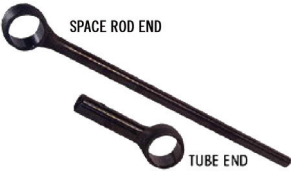

Date: June 2019

Document: PH-18100



ONE PIECE TORQUE RODS	DESCRIPTION
	<p>These are available in variety of sizes and bushing styles depending on the application. These torque rods can be found in the parts list or illustrated section for each suspension type or in the back section of the catalog containing all Euclid Torque Rods. And almost any one piece torque rod that is not included in this catalog can be ordered through Euclid's and Meritor's S.O.S. program</p>
<p>TWO PIECE TORQUE RODS</p>	
<p>Three different styles of two piece torque rods are available from Euclid, Meritor and Hendrickson. These require measurement, cutting to length and welding in the field to produce the required torque rod. This design reduces inventory and provides the maximum flexibility when servicing a fleet customer.</p>	
	<p>Hendrickson Ultra Rod - Euclid stocks both ends with a wide variety of bushings to cover virtually every application. The empty hub end and empty spacer ends that require the proper bonded bushings without the outer metal sleeve</p>
 <p>SPACE ROD END</p> <p>TUBE END</p>	<p>Hendrickson Ultra Rod Plus - Euclid stocks the empty hub end and empty spacer ends that require Ultra Rod Plus Bushings.</p>
	<p>Hendrickson Ultra Rod Plus with XTRB Bushings - These two piece torque rods are available with the severe duty XTRB bushings via Euclid's and Meritor's S.O. S. program.</p>

Hendrickson Suspension Torque Rod Assemblies



Date: June 2019

Document: PH-18100

TYPES OF BUSHINGS	DESCRIPTION
	Conventional (Clevite Style) Bushings with Outer Metal Sleeve - Used for many years by many different manufacturers. Most suitable for standard duty applications.
	Ultra Rod and Ultra Rod Plus Bushings (No Outer Metal Sleeve) - Newer designs with improved rubber to metal bonding and recommended for vocational applications.
	XTRB Bushings with Outer Metal Sleeve - Designed with superior bonding and mechanical designs including hardened steel pin and steel sleeve for severe duty applications.

Hendrickson Suspension Torque Rod Assemblies



MERITOR

Date: June 2019

Document: PH-18100

Replacement Cartridges for Conventional Clevite Style Torque Rods (With Outer Metal Sleeve)

	EUCLID	MERITOR	OEM REF	A	B	C	SERIES	THREADS
	E-2225	R302225	Clevite 227710; Hendrickson 44694-000	2 1/2"	4 3/8"	5/8"	340	-
	E-9395	R309395	Hendrickson 57256-001	2 1/2"	4 3/8"	7/8"	-	-
	E-2226	R302226	Clevite 227720; Hendrickson 44695-000	2 3/4"	4 3/8"	5/8"	400/460	-
	E-3868	R303868	Clevite 227723; Hendrickson 49210-000	2 3/4"	4 3/8"	3/4"	400/460	-
	E-15175	R3015175	Hendrickson 48304-000	3 1/2"	5 1/4"	7/8"	650/700	-
	E-2814	R302814	Clevite 233931 (Offset Pin); Hendrickson 46734-000	2 3/4"	5 11/16"	3/4"	Navistar	-
	E-3411	R303411	Clevite 4224001; Navistar 438506C91; Hendrickson 47699-001	3"	5 11/16"	3/4"	-	-
	E-5276	R305276	47692-000	2"	3"	7/8"	-	-
	E-11447	R3011447	Hendrickson 65477-000	2"	3 1/4"	1 1/8"	Navistar	-
	E-2816	R302816	Clevite 229612; Hendrickson 46736-000	2 3/4"	3 1/4"	1 1/8"	Navistar	-
	E-1351	R301351	24504-000	2 7/8"	3 1/4"	1 1/8"	-	-
	E-2238	R302238	Clevite 224993; Hendrickson 45477-000	3"	3 1/4"	1 1/8"	Navistar	-
	E-1352	R301352	44993-000	3 3/8"	3 1/4"	1 1/8"	-	-

Hendrickson Suspension Torque Rod Assemblies



Date: June 2019

Document: PH-18100

Replacement Cartridges for Conventional Clevite Style Torque Rods (With Outer Metal Sleeve)								
	EUCLID	MERITOR	OEM REF	A	B	C	SERIES	THREADS
	E-2227	R302227	Clevite 229270; Hendrickson 44809-000	2 1/4"	2"	6 5/8"	340	1 1/8"
	E-2815	R302815	Clevite 229240; Hendrickson 46735-000	2 3/4"	1 7/8"	7"	Mack	1 1/4"
	E-2916	R302916	Clevite 233890; Hendrickson 46737-000	2 3/4"	2"	6 5/8"	340	1 1/8"
	E-2228	R302228	Clevite 229610; Hendrickson 44697-000	2 3/4"	3"	8"	400; 460	1 1/4"

Lock Nuts and Washers for Tapered Stud Torque Rods							
	EUCLID	MERITOR	OEM REF	THREAD	HEX	HIGH	SERIES
	E-2079	R302079	Hendrickson 29896	1 1/8" -12	1 5/8"	1 3/16	340
	E-2017	R302017	Hendrickson 29749	1 1/4"-12	1 13/16"	11/16"	400, 460

	EUCLID	MERITOR	OEM REF	OD	ID	THICK	SERIES
	E-2018	R302018	Hendrickson 30574	2 1/4"	1 5/16"	1/4"	400,460

Hendrickson Suspension Torque Rod Assemblies



Date: June 2019

Document: PH-18100

Replacement Bonded Bushings for Hendrickson Ultra Rod® (No Metal Outer Sleeve)								
Straddle	EUCLID	MERITOR	OEM REF	A	B	C	NOTES	APPLICATION
	E-5275	R305275	47691-000	2"	4 3/8"	5/8"		For Use in Ultra Rod Torque Rods
	E-10322	R3010322	69210-000	2"	4 3/8"	3/4"		
	E-16466	R3016466	67746-000	2"	4 3/8"	7/8"		
	E-13970	R3013970	664400-005	3 1/4"	4 3/8"	3/4"	Can Replace E-3868 Metal Sleeve Style Bushing	For Use in Ultra Rod PLUS Torque Rods
	E-13971	R3013971	64400-003	3 1/4"	5 1/4"	7/8"		
	E-13961	R3013961	64400-002	3 1/4"	4 3/8"	5/8"	Can Replace E-2226 Metal Sleeve Style Bushing	For Use in Ultra Rod PLUS Torque Rods
	E-13964	R3013964	64400-009	3 1/4"	5 11/16"	3/4"		
	E-10320	R3010320	66734-000	2"	5 11/16"	3/4"		For Use in Ultra Rod PLUS Torque Rods
Hollow Sleeve								
	E-13967	R3013967	64400-010	3 1/4"	3 1/4"	1 1/8"	Can Replace E-2816 Metal Sleeve Style Bushing	For Use in Ultra Rod PLUS Torque Rods

Hendrickson Suspension Torque Rod Assemblies



Date: June 2019

Document: PH-18100

Replacement Bonded Bushings for Hendrickson Ultra Rod® (No Metal Outer Sleeve)

Tapered	EUCLID	MERITOR	OEM REF	A	B	C	THREAD	APPLICATION	
	E-10308	R3010308	64809-000	2"	6 5/8"	2"	1 1/8"	For Use in Ultra Rod Torque Rods	
	E-10321	R3010321	66735-000	2"	7"	1 7/8"	1 1/4"		
	E-10309	R3010309	64697-000	2"	8"	3"	1 1/4"		
	E-13969	R3013969	64400-008	3 1/4"	6 5/8"	1 7/8"	Can Replace E-2916 Metal Sleeve Style Bushing	1 1/8"	For Use in Ultra Rod PLUS Torque Rods
	E-13965	R3013965	64400-007	3 1/4"	7"	1 3/4"	Can Replace E-2815 Metal Sleeve Style Bushing	1 1/4"	
	E-13962	R3013962	64400-004	3 1/4"	8"	3"	Can Replace E-2228 Metal Sleeve Style Bushing	1 1/4"	
	E-13972	R3013972	64400-006	3 1/4"	8 3/4"	3"		1 3/4"	

	EUCLID	MERITOR	GENUINE	OEM REF	APPLICATION	
	E-14346	R3014346		66086-001	For Ultra Rod Bushings	
	E-13974	R3013974		66086-000	For Ultra Rod Plus Bushings	

Hendrickson Suspension Torque Rod Assemblies



Date: June 2019

Document: PH-18100

Replacement XTRB Bushings for Hendrickson Ultra Rod® Plus™									
	EUCLID	MERITOR	OEM REF	A	B	C			
Straddle									
	E-14641	R3014641	66649-002	2	4 3/8"	5/8"			
	E-14642	R3014642	66649-003	2	5 1/4"	15/16"			
	E-14644	R3014644	66649-005	2	4 3/8"	13/16"			
	EUCLID	MERITOR	REPLACES	A	B	C	FASTENER THREAD (D)	FASTENER LOCKNUT (E)	FASTENER WASHER (F)
	E-14643	R3014643	66649-004	2 3/4"	8"	3"	1 1/4"	E-2017	E-2018

Hendrickson Suspension Torque Rod Assemblies



Date: June 2019

Document: PH-18100

Ultra Rod® - Tube End						
	EUCLID	MERITOR	HENDRICKSON NO	REPLACEMENT BUSHING	MOUNTING CENTER (A)	HOLE DIAMETER (INCHES)
Straddle Mount Tube End						
	E-10310	R3010310	66610-000	E-5275	4 3/8"	5/8"
	E-11784	R3011784	66766-000	E-16466	4 3/8"	7/8"
	E-11748	R3011748	66767-000	E-10322	4 3/8"	3/4"
Offset Straddle Mount -Tube End						
	E-10313	R3010313	66640-000	E-10320	5 11/16"	3/4"
Hollow Sleeve Tube End						
	E-10314	R3010314	66650-000	E-11447	-	1 1/8"

Hendrickson Suspension Torque Rod Assemblies



Date: June 2019

Document: PH-18100

Ultra Rod® - Tube End						
	EUCLID	MERITOR	HENDRICKSON NO	REPLACEMENT BUSHING	TAPER PIN (A)	THREAD (B)
Tapered Stud Tube End						
	E-10311	R3010311	66620-000	E-10308	1 7/8"	1 1/8"
	S.O.S.	S.O.S.	66769-000	E-10321	1 3/4"	1 1/4"
	E-10312	R3010312	66630-000	E-10309	2 3/4"	1 1/4"

Hendrickson Suspension Torque Rod Assemblies



Date: June 2019

Document: PH-18100

Ultra Rod® - Spacer End													
	EUCLID	MERITOR	OEM REF	REPLACEMENT BUSHING	MOUNTING CENTER (B)	HOLE DIAMETER (INCHES)							
Straddle Mount Rod													
	E-10315	R3010315	6661-000	E-5275	4 3/8"	5/8"							
	E-14727	R3014727	67047-000	E-10322	4 3/8"	3/4"							
	S.O.S.	S.O.S.	67048-000	E-16466	4 3/8"	7/8"							
	S.O.S.	S.O.S.	66768-000	E-10320	5 11/16"	3/4"							
Hollow Sleeve Rod													
	E-10319	R3010319	66701-000	E-11447	-	1 1/8"							
<table border="1"> <thead> <tr> <th></th> <th>EUCLID</th> <th>MERITOR</th> <th>HENDRICKSON NO.</th> <th>REPLACEMENT BUSHING</th> <th>TAPER PIN (B)</th> <th>THREAD (C)</th> </tr> </thead> </table>								EUCLID	MERITOR	HENDRICKSON NO.	REPLACEMENT BUSHING	TAPER PIN (B)	THREAD (C)
	EUCLID	MERITOR	HENDRICKSON NO.	REPLACEMENT BUSHING	TAPER PIN (B)	THREAD (C)							
Tapered Stud Rod													
	E-10318	R3010318	66691-000	E-10321	1 3/4"	1 1/4"							
	E-10316	R3010316	66671-000	E-10308	1 7/8"	1 1/8"							
	E-10317	R3010317	66681-000	E-10309	2 3/4"	1 1/4"							

Hendrickson Suspension Torque Rod Assemblies



MERITOR

Date: June 2019

Document: PH-18100

Ultra Rod® - Option Configurations

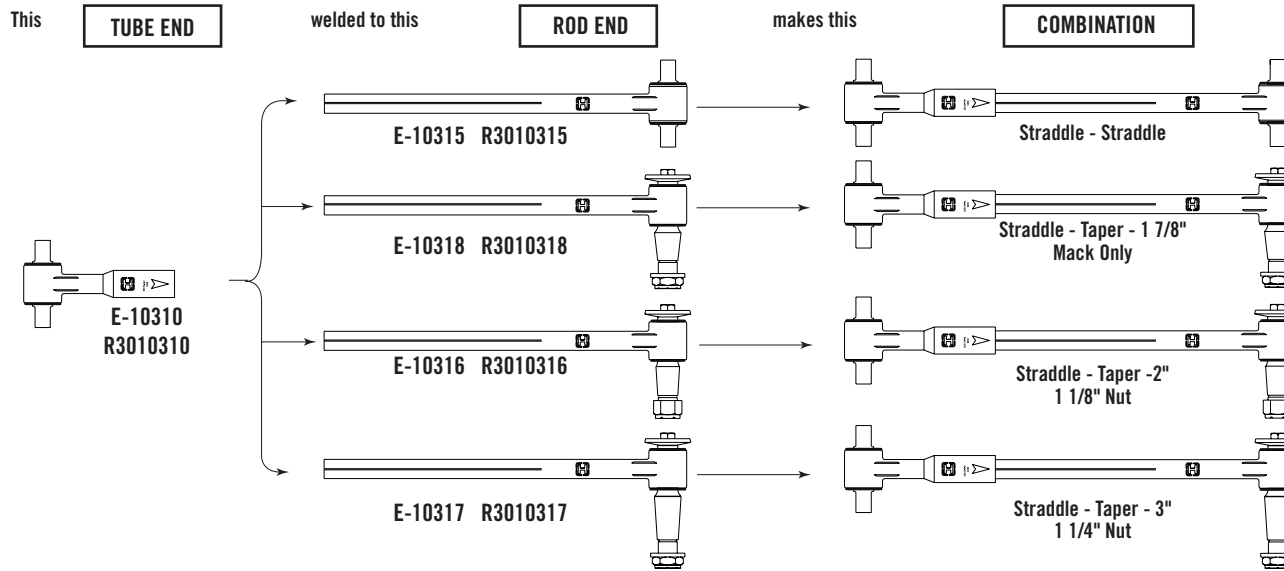

Continued on next page.

Hendrickson Suspension Torque Rod Assemblies



MERITOR

Date: June 2019

Document: PH-18100

Ultra Rod® - Option Configurations

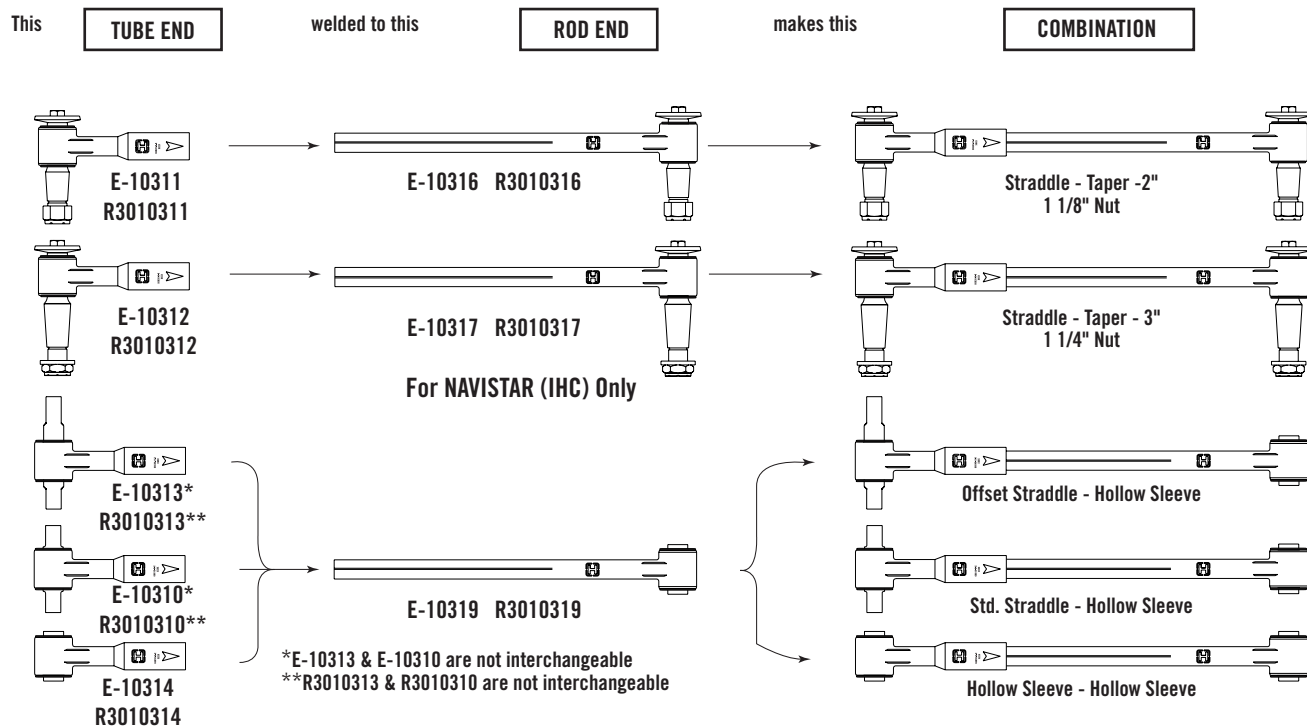

Hendrickson Suspension Torque Rod Assemblies



Date: June 2019

Document: PH-18100

Ultra Rod® Plus™

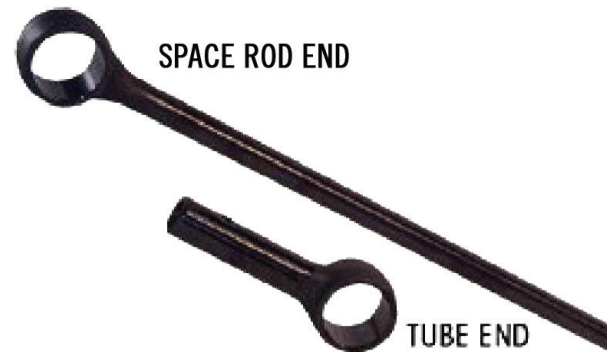

An excellent replacement option for vocational and on-highway applications.

Tube and spacer are made from one-piece forgings.

Empty Ends Hubs - offer added versatility to ULTRA ROD PLUS torque rods. Empty end hubs allow the use of any PLUS bushing configuration from existing Hendrickson torque rods. The two-piece design requires stocking only two part numbers, eliminating multiple torque rod inventory. Refer to Torque Rod Bushings Section for specific torque rod bushing information

Hendrickson Suspension Torque Rod Assemblies



Date: June 2019

Document: PH-18100

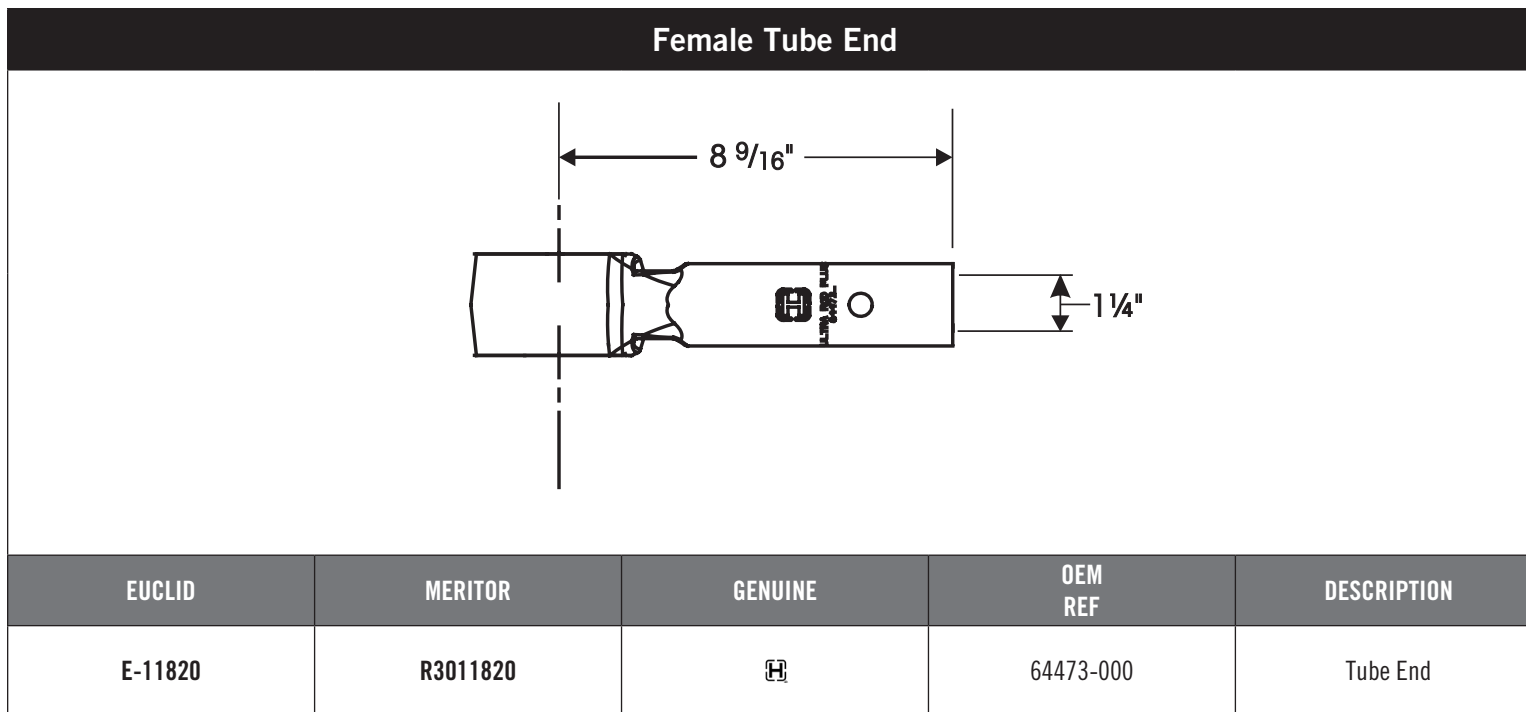

Hendrickson Suspension Torque Rod Assemblies



Date: June 2019

Document: PH-18100

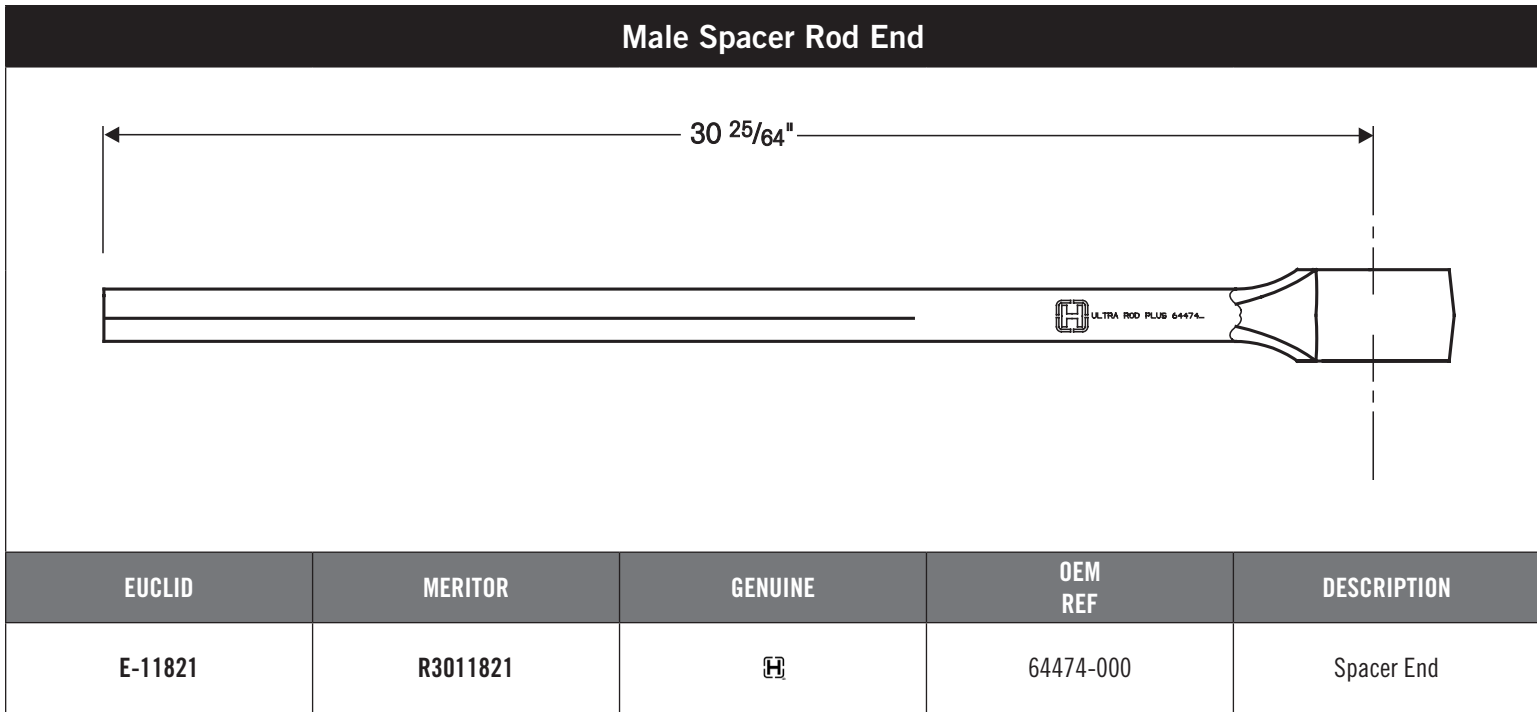

Hendrickson Suspension Torque Rod Assemblies



Date: June 2019

Document: PH-18100

Ultra Rod Bushing Installation Tool



EUCLID	MERITOR	GENUINE	OEM REF	DESCRIPTION
E-13974	R3013974		66086-000	For Ultra Rod Plus Bushings