

SUSPENSION CATALOG COMPONENTS



MERITOR



SPECIALTY POLYURETHANE	3
SERVICE TOOLS	25
TRAILER KING PIN & FIFTH WHEEL PARTS	27
THREADED RODS & U-BOLT ASSEMBLIES	29
U-BOLT ASSEMBLIES	32
SPRING CENTER BOLTS	39
SUSPENSION BOLTS	40
SUSPENSION NUTS	43
SUSPENSION WASHERS	45
EQUALIZER-TO-SUSPENSION MODEL GUIDE	47
EQUALIZERS	51
TORQUE ARMS	57
TORQUE ROD / ARM KITS	
UNI-ROD® KITS	78
HENDRICKSON ULTRA ROD® KITS	82
HENDRICKSON ULTRA ROD® PLUS™ KITS	85
SUSPENSION BUSHINGS	86
SPRING PINS	94
SPRING EYE BUSHINGS	98
HEIGHT CONTROL VALVES	100
SUSPENSION VALVES & ACCESSORIES	127
HEIGHT CONTROL VALVE AND ACCESSORIES CROSS REFERENCE	128
NUMERICAL LISTING	129

NOTES: _____

"The Problem Solvers When Rubber Won't Last" For Severe Service Applications

Meritor's line of Specialty Polyurethane Components has been designed to meet the severe service needs of the Heavy-Duty Trucking industry. Through extensive field testing, product design and compound development, a new and unique polyurethane material has evolved called "Double Bond."

"Double Bond" polyurethane is a unique material that offers the elasticity of rubber with the toughness and durability of metal. "Double Bond," unlike natural rubber compounds, has outstanding strength and abrasion characteristics, provides for excellent aging, and offers resistance to oils, fuels and ozone. Test results have shown "Double Bond" to outperform natural rubber components by approximately three to ten times depending upon application.

These Specialty Polyurethane Components have proven to be ideally suited for tanker, logging, refuse and construction applications where the extreme loads create the special need for longer lasting "Double Bond" Polyurethane Components.



Listed Alphabetically by OEM

Spring Eye Bushing - Cambria				
				
MERITOR NO.	OEM REF	OD	ID	LENGTH
R307447	Cambria A80BL0017	1 1/2"	7/8"	2 3/4"

Torque Arm Bushing - Chalmers				
				
Requires 4 per Torque Arm		Poly Version of Rubber Bushing R307766		
MERITOR NO.	OEM REF	LIP OD	ID	LENGTH
R307426	Chalmers 800010	4 1/4"	2 1/2"	2 1/8"

Torque Arm Bushing - Chalmers				
				
Requires 4 per Torque Arm		Poly Version of Rubber Bushing R304677A		
MERITOR NO.	OEM REF	LIP OD	ID	LENGTH
R307427	Chalmers 22129	3 5/8"	2 3/8"	1 7/8"

Oversize Torque Arm Bushing - Chalmers				
				
Requires 4 per Torque Arm		Poly Version of Rubber Bushing R307767		
MERITOR NO.	OEM REF	LIP OD	ID	LENGTH
R308917	Chalmers 800009	4 1/2"	2 1/2"	2 1/16"

SPECIALTY POLYURETHANE

Listed Alphabetically by OEM

SPECIALTY POLYURETHANE

Suspension Bushing - Crown Coach



MERITOR NO.	OEM REF	OD	ID	LENGTH
R307429	Crown Coach 3522-18	2 1/4" (Lg.) 2 3/4" (Sm)	1 1/4"	2 3/4"

Motor Mount - Freightliner



MERITOR NO.	OEM REF	OD	ID	HEIGHT
R307431	Freightliner CBA/24-650-17	2 3/8" (Lg.) 1 1/2" (Sm.)	21/32"	2 1/8"

Torque Arm Bushing - Dayton



Poly Version of Rubber Bushing R301980

MERITOR NO.	OEM REF	OD	ID	LENGTH
R307520	Dayton 39400016 Navistar 347374C1	1 29/32"	7/8"	3"

Motor Mount - Freightliner



MERITOR NO.	OEM REF	WIDTH	LENGTH	THICK	HOLE DIA.
R307430	Freightliner A01-11166-000	1 13/16"	2 13/16"	7/16"	11/16"

Fifth Wheel Bushing - Fontaine



MERITOR NO.	OD	ID	LENGTH
R307445	4"	1 1/4"	2 1/4"

Hood Pin - Freightliner



MERITOR NO.	OEM REF	OD	ID	HEIGHT
R3011853	Freightliner A17-10464-001	4"	1/2"	2 3/4"

Motor Mount - Ford



MERITOR NO.	OEM REF	OD	ID	LENGTH
R308918	Ford DOHZ-6068B	3"	1 1/2"	3"

Equalizer Bushing - Fruehauf

FOR MODELS:
F-2, J-2, T-1
and W24T1
Air Suspensions



Poly Version of Rubber Bushing R301020

MERITOR NO.	OEM REF	OD	ID	LENGTH
R307432	Fruehauf UXA-000004	3 1/2"	2"	4 3/8"

Listed Alphabetically by OEM

Equalizer Bushing Assembly - Fruehauf

FOR MODELS:
F-2, J-2, T-1
and W24T1
Air Suspensions



Poly Version of Rubber Bushing R301024

MERITOR NO.	OEM REF	INCLUDES
R309361	UXA-000004-900	2 Bushings, 1 Bolt, 2 Washers, 1 Nut

Spring End Pad - Fruehauf

FOR MODELS:
M2



Poly Version of Rubber Pad R303582

MERITOR NO.	OEM REF	WIDTH	LENGTH	THICKNESS
R308664	Fruehauf UCD-005635-001	7 5/8"	4 3/4"	1"

Torque Arm Bushing - Fruehauf

FOR MODELS:
F-2, J-2,
NF-2, &
NT



Poly Version of Rubber Bushing R30927

MERITOR NO.	OEM REF	OD	ID	LENGTH
R307433	Fruehauf UXA-000011	2 3/16"	1 1/4"	2 3/8"

Trunnion Bushing - General Trailer



MERITOR NO.	OEM REF	OD	ID	LENGTH
R307434	General 70-703	4 15/16"	4"	7 7/8"

Torque Arm Bushing Assembly - Fruehauf

FOR MODELS:
F-2, J-2,
NF-2, &
NT



Poly Version of Rubber Bushing R301023

MERITOR NO.	OEM REF	INCLUDES
R309362	UXA-000011- 900 (1/2)	2 Bushings, 1 Bolt, 2 Washers, Nut

Motor Mount - GMC



MERITOR NO.	OEM REF	OD	ID	HEIGHT
R307440	GMC 702727	3 1/4" (Lg.) 2 1/4" (Sm.)	5/8"	2 5/8"

Trunnion Bushing - Fruehauf

FOR MODELS:
M2



Poly Version of Rubber Bushing R303579

MERITOR NO.	OEM REF	OD	ID	LENGTH
R308663	Fruehauf UXA-000160	5"	4"	8 5/16"

Cab Mount - GMC





MERITOR NO.	OEM REF	OD	ID	HEIGHT
R307439	GMC 2005774 CBA/24-650-17	3 1/4" (Lg.) 1 5/8" (Sm.)	9/16"	2 1/4"

SPECIALTY POLYURETHANE

Listed Alphabetically by OEM

SPECIALTY POLYURETHANE

Motor Mount - GMC				
				
MERITOR NO.	OEM REF	OD	ID	LENGTH
R308650	GMC 15906936	2 3/8" Lg. 1 1/2" Sm.	5/8"	2 1/4"

Fifth Wheel Bushing - Holland				
				
MERITOR NO.	OEM REF	OD	ID	LENGTH
R307451	Holland 1604-5	2 3/4"	1 1/8"	4 1/4"

Fifth Wheel Bushing - Holland				
				
MERITOR NO.	OEM REF	OD	ID	LENGTH
R307450	Holland XB-0011-2	2 1/4"	1 1/8"	4 1/4"

Equalizer Bushing - Hutchens				
FOR MODELS: H-7600 H-7700				
				
Poly Version of Rubber Bushing R301999A				
MERITOR NO.	OEM REF	OD	ID	LENGTH
R307452	Hutchens 7010-00	3 1/4"	3/4"	3 7/8"

Fifth Wheel Bushing - Holland				
				
MERITOR NO.	OEM REF	OD	ID	LENGTH
R308652	Holland 1604-9	2 1/2"	1 1/2"	4 1/4"

Equalizer Bushing Assembly, 2 Hole Bushing - Hutchens	
FOR MODELS: H-7600 H-7700, CH7600, CH-7700	
	
Poly Version of Rubber Bushing R302003	
MERITOR NO.	INCLUDES
R309474	2 Step Bolts, 2 Nuts, 1 Lock Tab

Fifth Wheel Bushing - Holland				
				
MERITOR NO.	OEM REF	OD	ID	LENGTH
R308927	Holland XB-0012-2	2 1/4"	1 7/16"	4 1/4"

Equalizer with Poly Bushing - Hutchens	
FOR MODELS: H-7600, H-7700	
	
Poly Version of Rubber Bushing R302781A	
MERITOR NO.	NOTES
R307918	2 Hole Poly Bushing

Listed Alphabetically by OEM

Equalizer Bushing - Hutchens

FOR MODELS:
H-9600, H-9700



Poly Version of Rubber Bushing R307621

MERITOR NO.	OEM REF	OD	ID	LENGTH
R308666	Hutchens 16146-01	3 1/2"	1 1/8"	3 7/8"

Torque Arm Bushing Assembly - Hutchens

FOR MODELS:
H-7700, CH7700
H-9700, CH-9700



Poly Version of Rubber Bushing R303079

MERITOR NO.	INCLUDES
R309486	1 Bushing, 1 Bolt, 1 Nut

Equalizer Bushing Assembly, 1 Hole - Hutchens

FOR MODELS:
H-9600, H-9700,
CH-9600,
CH-9700



Poly Version of Rubber Bushing R309472

MERITOR NO.	INCLUDES
R309473	1 Equalizer Bolt, 1 Nut, 2 Washers

Torque Arm Bushing - Hutchens

FOR MODELS:
H-7600, H-9600
CH-7600, CH-9600



Poly Version of Rubber Bushing E-927

MERITOR NO.	OEM REF	OD	ID	LENGTH
R307433	Hutchens UXA-000011	2 3/16"	1 1/4"	2 3/8"

Equalizer with Poly Bushing - Hutchens

FOR MODELS:
H-9600, H-9700



Poly Version of Rubber Bushing R307532

MERITOR NO.	NOTES
R309567	1 Hole Poly Bushing

Torque Arm Bushing Assembly - Hutchens

FOR MODELS:
H-7600, H-9600
CH-7600, CH-9600



Poly Version of Rubber Bushing R309478

MERITOR NO.	INCLUDES
R309479	1 Bolt, 1 Nut, 2 Washers

Torque Arm Bushing - Hutchens

FOR MODELS:
H-7700, H-9700



Poly Version of Rubber Bushing R30934 & R3016504

MERITOR NO.	OEM REF	OD	ID	LENGTH
R307453	Hutchens 722-00	1 29/32"	1"	3"

Trunion Bushing - Hutchens

FOR MODEL:
H-900



Poly Version of Rubber Bushing R305216

MERITOR NO.	OEM REF	OD	ID	LENGTH
R307455	Hutchens 11357-00	5"	4"	9"

SPECIALTY POLYURETHANE

Listed Alphabetically by OEM

SPECIALTY POLYURETHANE

Trunnion Bushing - Hutchens

FOR MODELS:
H11455



Poly Version of Rubber Bushing R302935

MERITOR NO.	OEM REF	OD	ID	LENGTH	MATERIAL
R307443	11455-00	4 1/2"	3 1/2"	5 3/4"	Poly

Brownie Washer - Kenworth



Use with R307460 as a Set

MERITOR NO.	OEM REF	OD	ID	THICKNESS
R307461	Kenworth K363-275	2 1/4"	1 5/64"	3/8"

Spring End Pad - Hutchens

For Models
H4040, H900



Poly Version of Rubber Bushing R305227, R3016519

MERITOR NO.	OEM REF	LENGTH	WIDTH	THICKNESS
R308665	Hutchens 814-00	5"	2 7/8"	13/16"

Brownie Mount - Kenworth



Use with R307461 as a Set

MERITOR NO.	OEM REF	OD	ID	HEIGHT
R307460	Kenworth K066-269	2 1/4"	7/8"	1 1/64"

Suspension Bushing - Hyster



MERITOR NO.	OEM REF	OD	ID	LENGTH
R307457	Hyster 400329	5 21/32"	3"	2 7/8"

Rear Cab Mount - Kenworth



MERITOR NO.	OEM REF	LARGE OD	SMALL OD	ID	HEIGHT
R307462	Kenworth M600	3"	1 7/8"	5/8"	2 1/2"

Battery Box Washer - Kenworth



MERITOR NO.	OEM REF	OD	ID	THICKNESS
R307459	Kenworth K363-409	1 1/2"	3/8"	3/16"

Rear Cab Mount - Kenworth

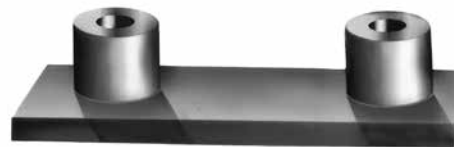

MERITOR NO.	WIDTH	LENGTH	HEIGHT
R307463	3 1/16"	9 3/8"	2 5/16"

Listed Alphabetically by OEM

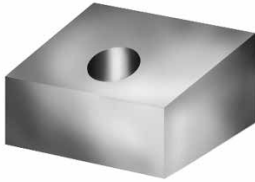
Door Jamb - Kenworth				
				
MERITOR NO.	OEM REF	WIDTH	LENGTH	HEIGHT
R307465	Kenworth K036-136	1 9/16"	1 3/4"	7/8"

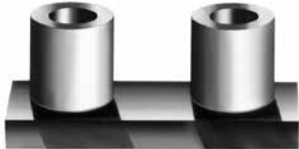
Motor Mount - Kenworth				
				
MERITOR NO.	OEM REF	WIDTH	LENGTH	HEIGHT
R307468	Kenworth M506-70NR	2"	5 1/2"	2 3/8"

Hood Pin - Kenworth				
				
MERITOR NO.	OEM REF	OAL	THREAD SIZE	THREAD LENGTH
R307467	Kenworth K179D450	4 13/16"	1/2" - 13	1"

Motor Mount - Kenworth					
					
MERITOR NO.	OEM REF	OD	ID	HOLE DIA.	WIDTH
R307470	Kenworth K174-155 K174B456	4 1/2"	3 1/2"	3/4" x 1 1/4"	2"

Motor Mount - Kenworth				
				
MERITOR NO.	OEM REF	OD	ID	HEIGHT
R307469	Kenworth K700	3 25/32" (Lg.) 2 1/16" (Sm.)	3/4"	2 19/32"

Radiator Mount - Kenworth				
				
MERITOR NO.	OEM REF	OD	ID	HEIGHT
R307471	Kenworth M500	2 13/64" (Lg.) 1 1/2" (Sm.)	5/8"	2 3/16"

Hood Hinge Bushing - Kenworth				
				
MERITOR NO.	OEM REF	OD	ID	HEIGHT
R307466	Kenworth M300	1 13/16" (Lg.) 1 3/16" (Sm.)	1/2"	1"

Mount - Kenworth				
				
MERITOR NO.	OEM REF	OD	ID	HEIGHT
R307473	Kenworth M602	3 1/64" (Lg.) 1 53/64" (Sm.)	5/8"	1 15/16"

SPECIALTY POLYURETHANE

Listed Alphabetically by OEM

SPECIALTY POLYURETHANE

Stabilizer Bar Bushing - Kenworth

FOR MODELS:
Airglide 100



Poly Version of Rubber Bushing R304669

MERITOR NO.	OEM REF	OD	ID	LENGTH
R307446A	Kenworth CA-293	2 7/8"	2"	4"

Mount - Kenworth



MERITOR NO.	OEM REF	OD	ID	HEIGHT
R307472	Kenworth 814-00	3 1/64" (Lg.) 1 13/16" (Sm.)	21/32"	1 3/16"

Torsion Bar Bushing - Kenworth

FOR MODELS:
Airglide 200/400



MERITOR NO.	OD	ID	LENGTH	TORSION BAR DIA
R3010302 Poly Version of Rubber Bushing G-16107	3"	2 1/8"	2 7/8"	54mm
R3016122 Poly Version of Rubber Bushing G-16108	3"	2 1/4"	2 7/8"	58mm

Shock Bushing - Kenworth



MERITOR NO.	OEM REF	OD	ID	THICKNESS
R307474	Kenworth CA368-6	1 13/16"	5/8"	1 1/4"

Air Ride Bushing - Kenworth



MERITOR NO.	OEM REF	OD	ID	HEIGHT
R307475	Kenworth K066-162	3 3/4" (Lg.) 2 3/4" (Sm.)	2"	2 3/8"

Radiator Bushing - Kenworth





MERITOR NO.	OEM REF	OD	ID	HEIGHT
R307640	Kenworth K264-84	1 5/8" (Lg.) 3/4" (Sm.)	5/8"	1"

Listed Alphabetically by OEM

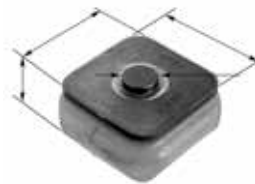
Motor Mount - Mack				
				
MERITOR NO.	OEM REF	OD	ID	HEIGHT
R307477	Mack 20QL1175 20QL1118A	3 1/4" (Lg.) 2" (Sm.)	3/4"	1 1/2"
R307641	Mack 20QL324M	3 3/4" (Lg.) 2 1/4" (Sm.)	7/8"	1 7/8"

Insulator Pad - Mack					
					
MERITOR NO.	OEM REF	WIDTH	LENGTH	HEIGHT	PIN DIA.
R307480	10QK36B 10QK388 Poly Version of Rubber Bushing R302920	6"	6"	3 3/4"	1 3/4"
R307481	10QK365A Poly Version of Rubber Bushing R302917	4 1/2"	6"	2 1/2"	1 3/4"
R308667	10QK370 Poly Version of Rubber Bushing R302919	4 1/2"	6"	3"	1 3/4"

Trunion Bushing - Mack				
				
MERITOR NO.	OEM REF	OD	ID	LENGTH
R307478	Mack 10QK219P1 Poly Version of Rubber Bushing R302921A	4 11/16"	3 7/16"	5 9/16"
R307479	Mack 10QK219P2, 10QL276 Poly Version of Rubber Bushing R302922A	4 11/16"	3 7/16"	6 5/16"
R307441	Mack 10QK130P1 Poly Version of Rubber Bushing R302924A	4 7/16"	3 7/16"	8 3/8"

Torque Arm Bushing - Meritor			
			
Poly Version of Rubber Bushing R309361			
MERITOR NO.	OEM REF	OD	LENGTH CENTER-TO-CENTER
R308655	Meritor A-2297-K-1051	4 1/8"	5 1/4"

Cabover Hinge Bushing - Navistar				
				
MERITOR NO.	OEM REF	OD	ID	LENGTH
R307482	Navistar 987395R2	1 5/8"	3/4"	3/16"

SPECIALTY POLYURETHANE

Listed Alphabetically by OEM

Hood Pin - Navistar



MERITOR NO.	OEM REF	OD	ID	LENGTH
R307483	Navistar 472697C1	2 3/8" (Lg.) 1 3/4" (Sm.)	2 7/8"	5/16" - 18

Radiator Support Bushing - Navistar



MERITOR NO.	OEM REF	OD	ID	HEIGHT
R307643	Navistar 200106R1	1 1/2" (Lg.) 7/8" (Sm.)	5/8"	3/4"

Motor Mount - Navistar



MERITOR NO.	OEM REF	OD	ID	HEIGHT
R307484	Navistar 753997C93	3" (Lg.) 2" (Sm.)	5/8"	2 1/4"

Cab Mount Bushing - Navistar



MERITOR NO.	OEM REF	OD	ID	HEIGHT
R307644	Navistar 270203C1	1 1/3" (Lg.) 7/8" (Sm.)	1/2"	3/4"

Axle Wrapper - Neway

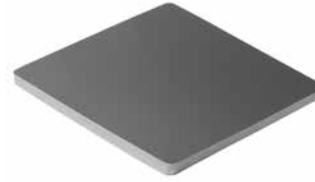

MERITOR NO.	OEM REF	WIDTH	LENGTH	THICKNESS
R308673	Neway 90028007	7 1/4"	7 1/4"	3/8"
Poly Version of Rubber Bushing R302009				
R308678	Neway 90028047	8"	7 1/4"	1/2"
Poly Version of Rubber Bushing R302943				
R308679	Neway 91028051	9"	5"	3/4"
Poly Version of Rubber Bushing R302945				

Axle Pad - Neway



Poly Version of Rubber Bushing R302010 & R302947A

MERITOR NO.	OEM REF	LENGTH	WIDTH	THICKNESS
R308674	Neway 90028007	7"	5 5/8"	3/8"
R308680	Neway 90028075	7 1/16"	5 5/8"	7/16"

Beam Pivot Bushing - Neway



Poly Version of Rubber Bushing R304255

MERITOR NO.	OEM REF	OD	ID	LENGTH
R307485	Neway 90008131	2 3/8"	1 1/8"	5"

Listed Alphabetically by OEM

Beam Bushing - Neway



Poly Version of Rubber Bushing R304253

MERITOR NO.	OEM REF	OD	ID	LENGTH
R308681	Neway 90008008	3 7/8"	2 1/2"	5 3/4"

Beam Bushing - Neway



Poly Version of Rubber Bushing R304257

MERITOR NO.	OEM REF	METAL OD		METAL ID		LENGTH
		SM.	LG.	SM.	LG.	
R308682	Neway 90008113	2 7/8"	3 5/8"	2 9/16"	3 1/4"	2 5/8"

Beam End Bushing - Neway



Poly Version of Rubber Bushing R304382A

MERITOR NO.	OEM REF	OD	ID	LENGTH
R308683	Neway 90008139	3 1/2"	1 1/8"	5 1/4"

Shock Absorber Bushing - Neway



Poly Version of Rubber Bushing R304403

MERITOR NO.	OEM REF	OD		ID	LENGTH
		SM.	LG.		
R308684	Neway 90508004	1 1/4"	1 17/32"	3/4"	15/16"

Beam End Bushing - Neway



Poly Version of Rubber Bushing R304410A

MERITOR NO.	OEM REF	OD	ID	LENGTH
R307444	Neway	2 3/4"	1 1/8"	5"

Trunnion Bushing - Neway



MERITOR NO.	OEM REF	OD	ID	LENGTH
R307442	Neway 91008040	4 1/2"	3 1/2"	3 1/2"
R307443 Poly Version of Rubber Bushing R302935	Neway 90008011	4 1/2"	3 1/2"	5 3/4"
R308672 Poly Version of Rubber Bushing R301333	Neway 91008014	5"	4"	5 3/4"

Beam End Bushing - Neway



Poly Version of Rubber Bushing R302940

MERITOR NO.	OEM REF	OD	ID	LENGTH
R308677	Neway 90008002	2 3/8"	1 1/4"	5"

SPECIALTY POLYURETHANE

Listed Alphabetically by OEM

SPECIALTY POLYURETHANE

Spring End Pad - Neway



MERITOR NO.	OEM REF	OD	ID	LENGTH
R308669	Neway 91028013	5 1/8"	4 5/8"	5/8"
R308670 Poly Version of Rubber Bushing R301330	Neway 91028089	5 1/4"	4 5/8"	13/16"
R308671 Poly Version of Rubber Bushing R301331	Neway 91028023	5 7/16"	1 5/8"	11/16"

Trunnion Bushing - Page



MERITOR NO.	OEM REF	OD	ID	LENGTH
R307487	-	4 1/4"	3 1/4"	4"
R307488	X1004782	4 1/2"	3 1/2"	4"
R307489	X1004785	4 1/2"	3 1/2"	8 3/4"
R307491	X1003544	4 13/16"	3 7/8"	4 11/16"
R307492	X1006731	5"	4"	4 11/16"
R307486	1083483	5"	4"	8 3/4"
R307493	X1003546	5 1/2"	4 1/2"	4 7/8"

Trunnion Bushing - Neway



Poly Version of Rubber Bushing R301332

MERITOR NO.	OEM REF	OD	ID	LENGTH
R307486 (Poly)	Neway 91008022	5"	4"	8 3/4"

Trunnion Bushing - Peerless



MERITOR NO.	OEM REF	OD	ID	LENGTH
R307449	Peerless 36-500	5"	4"	10 3/8"

Torque Arm Bushing - Neway



Poly Version of Rubber Bushing R302939

MERITOR NO.	OEM REF	OD	ID	LENGTH
R308676	Neway 91008007	2 3/8"	1 1/4"	2 1/2"

Reach Cradle - Peerless



MERITOR NO.	OEM REF	OD	ID	LENGTH
R307497	Peerless 31-20623	4"	11 5/8"	4 1/2"

Listed Alphabetically by OEM

Trunnion Bushing - Peerless



MERITOR NO.	OEM REF	OD	ID	LENGTH
R307434	Peerless 36-10	4 15/16"	4"	7 7/8"

Pivot Arm Bushing - Peerless



MERITOR NO.	OEM REF	OD	ID	LENGTH
R307500	Peerless	3 1/2"	2 1/2"	7"

Trailing Arm Bushing - Peerless



MERITOR NO.	OEM REF	OD	ID	LENGTH
R307499	Peerless 36-15	4 1/2"	3 1/2"	10 1/2"

Hood Hinge Bushing - Peterbilt



MERITOR NO.	OEM REF	WIDTH	LENGTH	HEIGHT
R307502	Peterbilt 13-03318	1 3/8"	1 13/16"	1 1/4"

Hood Pin - Peterbilt



MERITOR NO.	OEM REF	OAL	THREAD SIZE	THREAD LENGTH
R307504	Peterbilt 13-01840	6 35/64"	5/8"-18	3 7/8"

Hood Hinge Bushing - Peterbilt



MERITOR NO.	OEM REF	OD	ID	LENGTH
R307503	Peterbilt 13-03440	1 3/8"	5/8"	1 5/8"

Walking Beam Bushing - Peerless



MERITOR NO.	OEM REF	OD	ID	LENGTH
R307498	Peerless 36-22	4 1/2"	3 1/2"	7 1/2"

Motor Mount - Peterbilt



MERITOR NO.	OEM REF	OD	ID	HEIGHT
R307506	Peterbilt 05-08968	2 1/2" (Lg.) 1 5/8" (Sm.)	5/8"	2"

SPECIALTY POLYURETHANE

Listed Alphabetically by OEM

SPECIALTY POLYURETHANE

Motor Mount - Peterbilt



MERITOR NO.	OEM REF	OD	ID	HEIGHT
R307462	Peterbilt 05-14794	3" (Lg.) 1 7/8" (Sm.)	5/8"	2 1/2"

Motor Mount - Peterbilt



MERITOR NO.	OEM REF	OD	ID	HEIGHT
R307469	Peterbilt 05-08969	3 13/16"(Lg.) 2 1/16"(Sm.)	3/4"	2 19/32"

Motor Mount - Peterbilt



MERITOR NO.	OEM REF	OD	ID	HEIGHT
R307507	Peterbilt 05-10197	2 7/8" (Lg.) 1 5/8" (Sm.)	1 3/16"	2 1/2"

Mount - Peterbilt



MERITOR NO.	OEM REF	OD	ID	HEIGHT
R307472	Peterbilt 07-03286	3" (Lg.) 1 13/16" (Sm.)	21/32"	1 3/16"

Cab Mount - Peterbilt



MERITOR NO.	OEM REF	OD		ID		LENGTH
		SM	LG	SM	LG	
R308919	Peterbilt 20-08257	2 9/32"	3"	5/8"	1 1/2"	1 7/16"

Radiator Mount - Peterbilt



MERITOR NO.	OEM REF	OD	ID	HEIGHT
R307448	Peterbilt 1" 3-01633	1" (Lg.) 13/16" (Sm.)	3/8"	15/16"

Hood Roller - Peterbilt



MERITOR NO.	OEM REF	OD	ID	LENGTH
R307505	Peterbilt 13-03439	2"	5/8"	1"

Air Ride Bushing - Peterbilt



Poly Version of Rubber Bushing R304775

MERITOR NO.	OEM REF	OD	ID	LENGTH
R307509	Peterbilt 03-01674	2 1/2"	1 3/4"	2 3/4"

Listed Alphabetically by OEM

Radiator Mount - Peterbilt



MERITOR NO.	OEM REF	OD	ID	LENGTH
R307508	Peterbilt 07-02552	1 3/16"	5/8"	11/16"

Eye Bushing - Premier



MERITOR NO.	OEM REF	OD	ID	LENGTH
R307645	Premier P-205	4 3/4"	2"	5 1/4"

Equalizer Bushing - Peterbilt



Heavy Duty Version of R304745

MERITOR NO.	OEM REF	OD	ID	LENGTH
R307510	Peterbilt 03-02099	3 1/8"	2 1/2"	2 1/4"

Equalizer Bushing - Reyco

FOR MODEL:
21B



Poly Version of Rubber Bushing R301159

MERITOR NO.	OEM REF	OD		ID	LENGTH
		SM	LG		
R308653	Reyco T-5524	2 3/4"	3 3/8"	1 5/8"	4 13/32"

Bushing - Premier



MERITOR NO.	OEM REF	OD	ID	LENGTH
R307515	344-A	3 1/2"	1 5/8"	4 1/2"
R307516	448-A	3 1/2"	2"	1 7/8"
R307517	348-A	3 1/2"	2"	3 1/2"
R307518	437-A	4 1/4"	2"	4 1/2"

Equalizer Assembly - Reyco

FOR MODELS:
21B Cast



Poly Version of Rubber Bushing R303976

MERITOR NO.	INCLUDES
R309555	1 Shaft, 2 R308653 Bushings, 2 Washers, 2 Bolts, 2 Lock Washers

Equalizer Bushing - Reyco

FOR MODEL:
21B -
72" Widespread



Poly Version of Rubber Bushing R301072

MERITOR NO.	OEM REF	OD	ID	LENGTH
R308688	Reyco T-3214	3 1/8"	2"	4 1/4"

SPECIALTY POLYURETHANE

Listed Alphabetically by OEM

SPECIALTY POLYURETHANE

Equalizer Bushing - Reyco

FOR MODEL:
21B-
72" Widespread



Poly Version of Rubber Bushing R30813

MERITOR NO.	OEM REF	OD	ID	LENGTH
R308691	Reyco T-2102	4 1/16"	2 3/8"	2 9/16"

Torque Arm Bushing - Reyco

FOR MODEL:
101A



Poly Version of Rubber Bushing R301980

MERITOR NO.	OEM REF	OD	ID	LENGTH
R307520	Reyco 09729-01	1 29/32"	7/8"	3"

Equalizer Bushing - Reyco

FOR MODEL:
101 (Ford)



Poly Version of Rubber Bushing R303977

MERITOR NO.	OEM REF	OD	ID	LENGTH
R308654	Reyco 14713-01	3 1/8"	1 1/2"	4 1/2"

Torque Arm Bushing Assembly - Reyco

FOR MODELS:
73, 73 WS,
79KB, 83



Poly Version of Rubber Bushing R301981

MERITOR NO.	INCLUDES
R309552	1 R307520 Bushing, 1 Bolt, 1 Nut

Torque Arm Bushing - Reyco

FOR MODEL:
21B



Poly Version of Rubber Bushing R301160

MERITOR NO.	OEM REF	OD		ID	LENGTH
		SM	LG		
R307523	Reyco	1 13/16"	2 3/8"	1"	3"

Torque Arm Bushing Assembly - Reyco / Transpro

FOR MODELS:
86-88



Poly Version of Rubber Bushing R304834A

MERITOR NO.	INCLUDES
R309551	1 R307520 Bushing, 1 Bolt, 1 Nut

Torque Arm Bushing Assembly - Reyco

FOR MODELS:
21B Cast, 21B Fab.,
21AR, 21B Cast,
21B Fab., 21AR, 101A



Poly Version of Rubber Bushing R301312A

MERITOR NO.	OEM REF	INCLUDES
R309545	TK-18997	2 R307523 Bushings, 1 Bolt, 1 Nut, 2 Washers

Torque Arm Bushing - Reyco

FOR MODEL:
102



Poly Version of Rubber Bushing R301982

MERITOR NO.	OEM REF	OD		ID	LENGTH
		SM	LG		
R307522	Reyco T-2242	1 3/4"	2 3/8"	1"	2 11/16"

Listed Alphabetically by OEM

Torque Arm Bushing - Reyco

FOR MODELS
101, 101A



Poly Version of Rubber Bushing R301964 End View

MERITOR NO.	OEM REF	OD		LENGTH
		SM	LG	
R308689	Reyco T1723	1 13/16"	3 1/16"	2 7/8"

Spring End Bushings - Silver Eagle



Sold only as a Pair

MERITOR NO.	OEM REF	OD	ID	LENGTH
R307526	Silver Eagle G-34/G-35	5"	1"	5 1/2"

Torque Arm Bushing - Reyco

FOR MODEL:
102



Poly Version of Rubber Bushing R3010057

MERITOR NO.	OEM REF	OD		ID	LENGTH
		SM	LG		
R309579	Reyco 21238-01S	1 13/16"	3 5/32"	1"	2 3/4"

Hinge Bushing - Silver Eagle



MERITOR NO.	OEM REF	OD	ID	LENGTH
R307525	Silver Eagle R-213	3 3/4"	2 1/2"	2 3/16"

Torque Arm Bushing Assembly - Reyco

FOR MODELS:
102, 102W
102CC, 102AR



Poly Version of Rubber Bushing R309530

MERITOR NO.	INCLUDES
R309583	2 R309519 Bushings, 1 Bolt, 1 Nut, 2 Washers

Hinge Bushing - Utility Trailer



MERITOR NO.	OEM REF	WIDTH	LENGTH	HEIGHT	HOLE DIA.
R307527	Utility Trailer 3-1306	3"	2 7/8"	3"	1 7/8"

Eye Bushing - Silver Eagle



MERITOR NO.	OEM REF	OD	ID	LENGTH
R307524	Silver Eagle R-205	4 3/4"	2 1/2"	5 3/16"

Motor Mount - Volvo



MERITOR NO.	OEM REF	OD	ID	LENGTH
R308918	Volvo 12004-0007	3"	1 1/2"	3"

SPECIALTY POLYURETHANE

Listed Alphabetically by OEM

SPECIALTY POLYURETHANE

Cab Tilt Bushing - Volvo



MERITOR NO.	OEM REF	OD	ID	LENGTH
R309506	Volvo 66108-0006, A80BL0024	2 1/8"	1 1/8"	2 13/16"

Hinge Bushing - Western Unit Dolly



MERITOR NO.	OEM REF	ID	LENGTH
R308656	Western Unit 102308	1 7/8"	3"

Cab Latch Insulator - Volvo



MERITOR NO.	OEM REF	LENGTH	WIDTH	LENGTH
R309507	Volvo 66206-0002, A80BL0025	2 1/4"	2"	3"

Listed Alphabetically by OEM

Shock Absorber Bushing



For All Makes of Shock Absorbers

MERITOR NO.	OD	ID	LENGTH
R307528	1 7/16"	3/4"	7/8"
R307529	1 7/8"	1"	1"

Beam Center Bushing



Misc. Applications Poly Version of Rubber Bushing R301339

MERITOR NO.	SMALL OD	LARGE OD	LENGTH
R309510	3 1/2"	4 3/4"	12"

Shock Bushing



MERITOR NO.	OD	ID	LENGTH
R307474	1 13/16"	5/8"	1 1/4"

Torque Arm Bushing

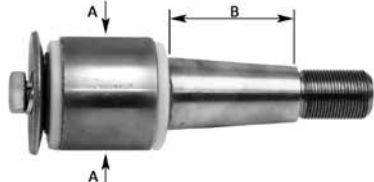

Misc. Applications Poly Version of Rubber Bushing R302228 & 2815

MERITOR NO.	OEM REF	A	THREAD	B
R308651	Clevite 229610	2 3/4"	1 1/4"-12	3"
R309518	Mack	2 3/4"	1 1/4"-12	1 7/8"

Torque Arm Bushing



Misc. Applications

MERITOR NO.	OEM REF	OD	LENGTH
R307638 Poly Version of Rubber Bushing R302225	Clevite 227710	2 17/32"	4 3/8"
R307639 Poly Version of Rubber Bushing R302226	Clevite 227720	2 3/4"	4 3/8"

Beam End Bushing



Misc. Applications

MERITOR NO.	OD	ID	LENGTH
R309512A	4 3/8"	2 1/2"	5 3/4"

SPECIALTY POLYURETHANE

Rubber To Polyurethane Suspension Components

INTERCHANGE			
MERITOR NO.		DESCRIPTION	MANUFACTURER
RUBBER	POLYURETHANE		
R30813	R308691	Equalizer Bushing	Reyco
R30927	R307433	Torque Arm Bushing	Fruehauf, Hutchens
R30934	R307453	Torque Arm Bushing	Hutchens, Trailmobile
R301020	R307432	Equalizer Bushing	Fruehauf
R301023	R309362	Torque Arm Bushing Assembly	Fruehauf
R301024	R309361	Equalizer Bushing Assembly	Fruehauf
R301072	R308688	Equalizer Bushing	Reyco
R301159	R308653	Equalizer Bushing	Reyco
R301160	R307523	Torque Arm Bushing	Reyco
R301312A	R309545	Torque Arm Bushing Assembly	Reyco
R301330	R308670	Spring End Pad	Neway
R301331	R308671	Spring End Pad	Neway
R301332	R307486	Trunnion Bushing	Neway
R301333	R308672	Trunnion Bushing	Neway
R301334	R307442	Trunnion Bushing	Fruehauf, Neway
R301339	R309510	Beam Center Bushing	Miscellaneous Application
R301341A	R309512A	Beam End Bushing	Hendrickson
R301940	R309515	Vertical Drive Bushing	Miscellaneous Application
R301963	R309548	Torque Arm Bushing Assembly	Reyco
R301964	R308689	Torque Arm Bushing	Reyco
R301980	R307520	Torque Arm Bushing	Dayton, Reyco/Transpro, Spicer, Hendrickson
R301981	R309552	Torque Arm Bushing Assembly	Reyco
R301982	R307522	Torque Arm Bushing	Reyco, Spicer
R301999A	R307452	Equalizer Bushing, 2 Hole	Hutchens
R302003	R309474	Equalizer Bushing Assembly, 2 Hole Bushing	Hutchens
R302009	R308673	Axle Wrapper	Neway
R302010	R308674	Axle Pad	Neway
R302225	R307638	Torque Rod Bushing	Clevite
R302226	R307639	Torque Rod Bushing	Clevite
R302228	R308651	Torque Arm Bushing	Clevite
R302232	R309514	Load Cushion	Miscellaneous Application
R302781A	R307918	Equalizer With 2 Hole Poly Bushing	Hutchens
R302815	R309518	Torque Arm Bushing	Miscellaneous Application
R302917	R307481	Insulator Pad	Mack
R302919	R308667	Insulator Pad	Mack
R302920	R307480	Insulator Pad	Mack
R302921A	R307478	Trunnion Bushing	Mack
R302922A	R307479	Trunnion Bushing	Mack
R302924A	R307441	Trunnion Bushing	Mack
R302935	R307443	Trunnion Bushing	Neway
R302939	R308676	Torque Arm Bushing	Neway
R302940	R308677	Beam End Bushing	Neway
R302943	R308678	Axle Wrapper	Neway

SPECIALTY POLYURETHANE

Rubber To Polyurethane Suspension Components

Suspension

SPECIALTY
POLYURETHANE

INTERCHANGE			
MERITOR NO.		DESCRIPTION	MANUFACTURER
RUBBER	POLYURETHANE		
R302945	R308679	Axle Wrapper	Neway
R302947A	R308680	Axle Pad	Hutchens, Neway
R303079	R309486	Equalizer Bushing Assembly	Hutchens
R303579	R308663	Trunnion Bushing	Fruehauf
R303582	R308664	Spring End Pad	Fruehauf
R303976	R309555	Equalizer Bushing Assembly	Reyco
R303977	R308654	Equalizer Bushing	Reyco
R304253	R308681	Beam Bushing	Neway
R304255	R307485	Beam Pivot Bushing	Neway
R304257	R308682	Beam Bushing	Neway
R304382A	R308683	Beam End Bushing	Neway
R304403	R308684	Shock Absorber Bushing	Neway
R304410A	R307444	Beam End Bushing	Neway
R304669	R307446A	Air Ride Bushing	Kenworth
R304677A	R307427	Torque Rod Bushing, Type 0 & 1 Connections	Chalmers
R304745	R307510	Equalizer Bushing	Peterbilt
R304775	R307509	Air Ride Bushing	Peterbilt
R304834A	R309551	Torque Arm Bushing Assembly	Reyco/Transpro
R305216	R307455	Trunnion Bushing	Hutchens
R305227	R308665	Spring End Pad	Hutchens
R307532	R309567	Equalizer With 1 Hole Poly Bushing	Hutchens
R307621	R308666	Equalizer Bushing, 1 Hole	Hutchens
R307766	R307426	Torque Rod Bushing Type 2 Connections	Chalmers
R307767	R308917	Torque Rod Bushing Oversize Type 2 Connections	Chalmers
R309321	R308655	Torque Arm Bushing	Meritor, Rockwell, Kenworth "Big 6"
R309350	R309583	Torque Arm Bushing Assembly	Reyco
R309472	R309473	Equalizer Bushing Assembly, 1 Hole Bushing	Hutchens
R309478	R309479	Torque Arm Bushing Assembly	Hutchens
R3010057	R309579	Torque Arm Bushing	Reyco
R3016107	R3010302	Torsion Bar Bushing 54mm	Kenworth
G-16108	R3016122	Torsion Bar Bushing 58mm	Kenworth
R3016501	R308666	Equalizer Bushing, 1 Hole	Hutchens
R3016502	R307455	Trunnion Bushing	Hutchens
R3016504	R307453	Torque Arm Bushing	Hutchens, Trailmobile
R3016519	R308665	Spring End Pad	Hutchens
R30401011	R307528	Shock Absorber Bushing	Gabriel
R30401754	R307529	Shock Absorber Bushing	Gabriel

Tool For Installing Hutchens, Trailmobile And Transpro Equalizer Bushings

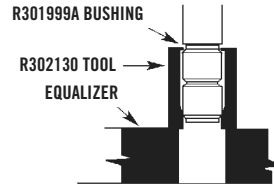

Use to install R301999A, R303394A, R304827 and R307621 Bushings.

MERITOR NO.	DIMENSION	NOTES
R302130	3 3/4" OD x 3 3/8" ID x 3 1/2" Long	Tool automatically centers bushing for perfect alignment and ease of installation.

Torque Arm Bushing Installation Tool

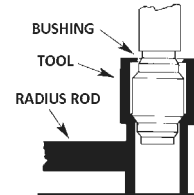

Use to install R30934 Bushing in Original Equipment Hutchens Torque Arms

MERITOR NO.	DIMENSION	NOTES
R301600	2 1/2" OD x 1 5/16" ID x 2 1/2" Long	For Hutchens Torque Arms

Universal Outside Thread Chaser

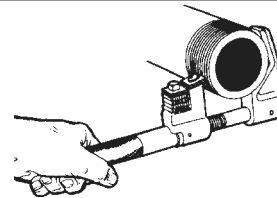

Restores threads to their original condition. Eliminates the need for expensive thread cutting equipment.

MERITOR NO.	CAPACITY	INSTRUCTIONS	NOTES
R302644	1 1/4" to 5" OD	Tighten the tool slightly on the good threads, then back off over the damaged thread area to restore the threads. The aluminum alloy V Pad will not damage the threads.	Complete with 6 dies — Threads per inch 4, 5, 6, 7, 7 1/2, 8, 9, 10, 11, 11 1/2, 12, 14, 16, 18, 20 and 24.

Hendrickson Bushing Installation Tool

FOR MODELS:
Hendrickson Trailer
with Wide Bushing



Bushings Not Included

MERITOR NO.	GENUINE	OEM REF	NOTES
R309575		S-21307	For Installation of Wide Tri-Functional Bushings.

Hendrickson Bushing Installation Tool

FOR MODELS:
Hendrickson Trailer
with Narrow Bushing



Bushings Not Included

MERITOR NO.	GENUINE	OEM REF	DESCRIPTION
R3014634		S-24736	For Installation of Narrow Bushing; AANL & AANLS Models

Hendrickson Torque Rod Bushing Installation Tool



MERITOR NO.	GENUINE	OEM REF	APPLICATION	
R3014346		66086-001	For Ultra Rod Bushings	
R3013974		66086-000	For Ultra Rod Plus Bushings	

SERVICE TOOLS

R30700 TRAILER KING PIN

King Pin

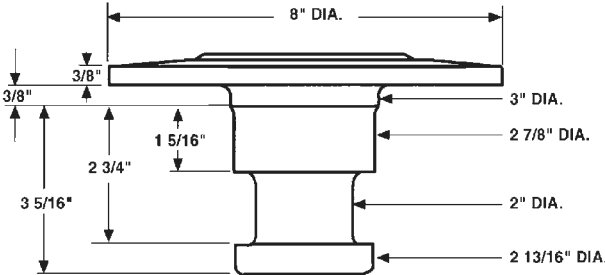
MERITOR NO.	NOTES
R30700	Various Applications with Weld-on King Pins. 8" Flange Diameter.

King Pin Lock



MERITOR NO.	NOTES
R30702A	Includes Keyed Lock

TRAILER KING PIN
FIFTH WHEEL PARTS

FIFTH WHEEL PARTS

Fifth Wheel Bushing - Holland



Polyurethane

MERITOR NO.	OEM REF	OD	ID	LENGTH
R307451	Holland 1604-5	2 3/4"	1 1/8"	4 1/4"
R308652	Holland 1604-9	2 1/2"	1 1/2"	4 1/4"

Fifth Wheel Bushing - Holland



Polyurethane

MERITOR NO.	OEM REF	OD	ID	LENGTH
R307450	Holland XB-0011-2	2 1/4"	1 1/8"	4 1/4"
R308927	Holland XB-0012-2	2 1/4"	1 7/16"	4 1/4"

NOTES: _____

THREADED ROD PART NUMBER DESIGNATION

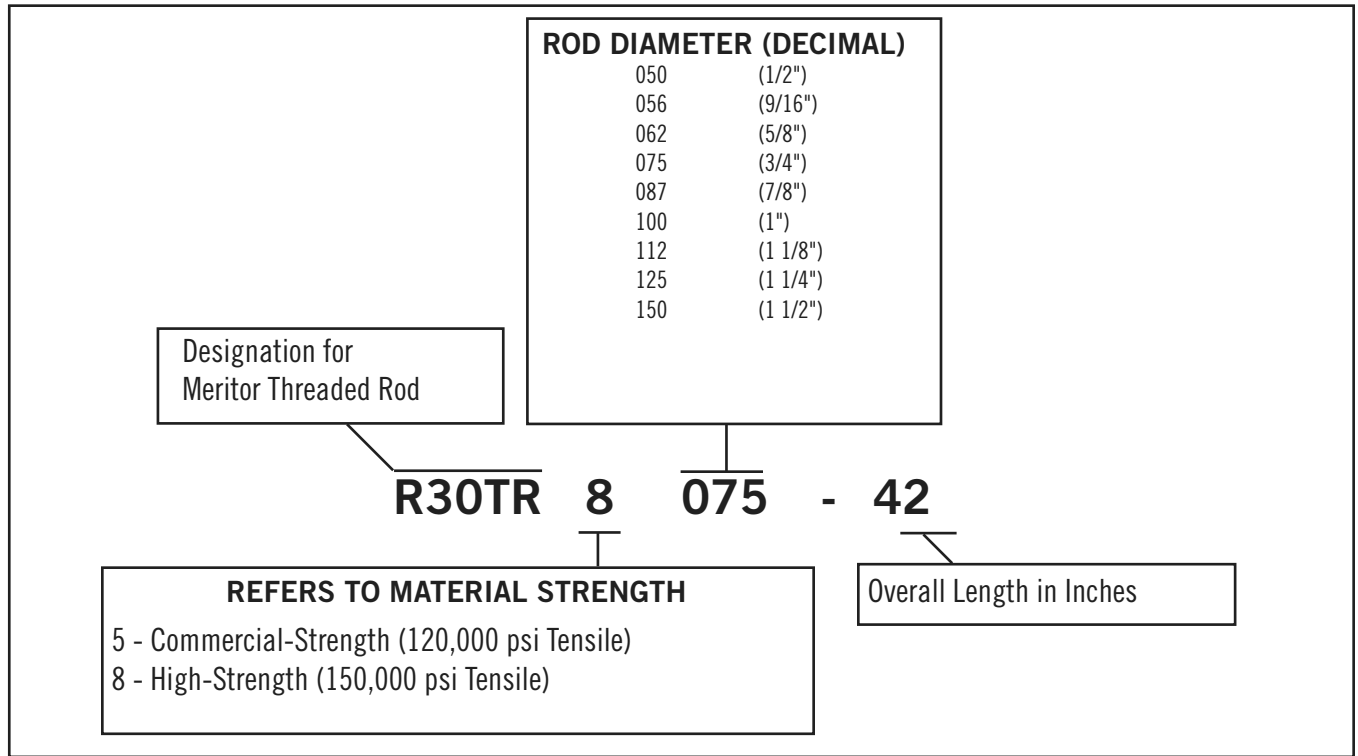

U-BOLT PART NUMBER DESIGNATION

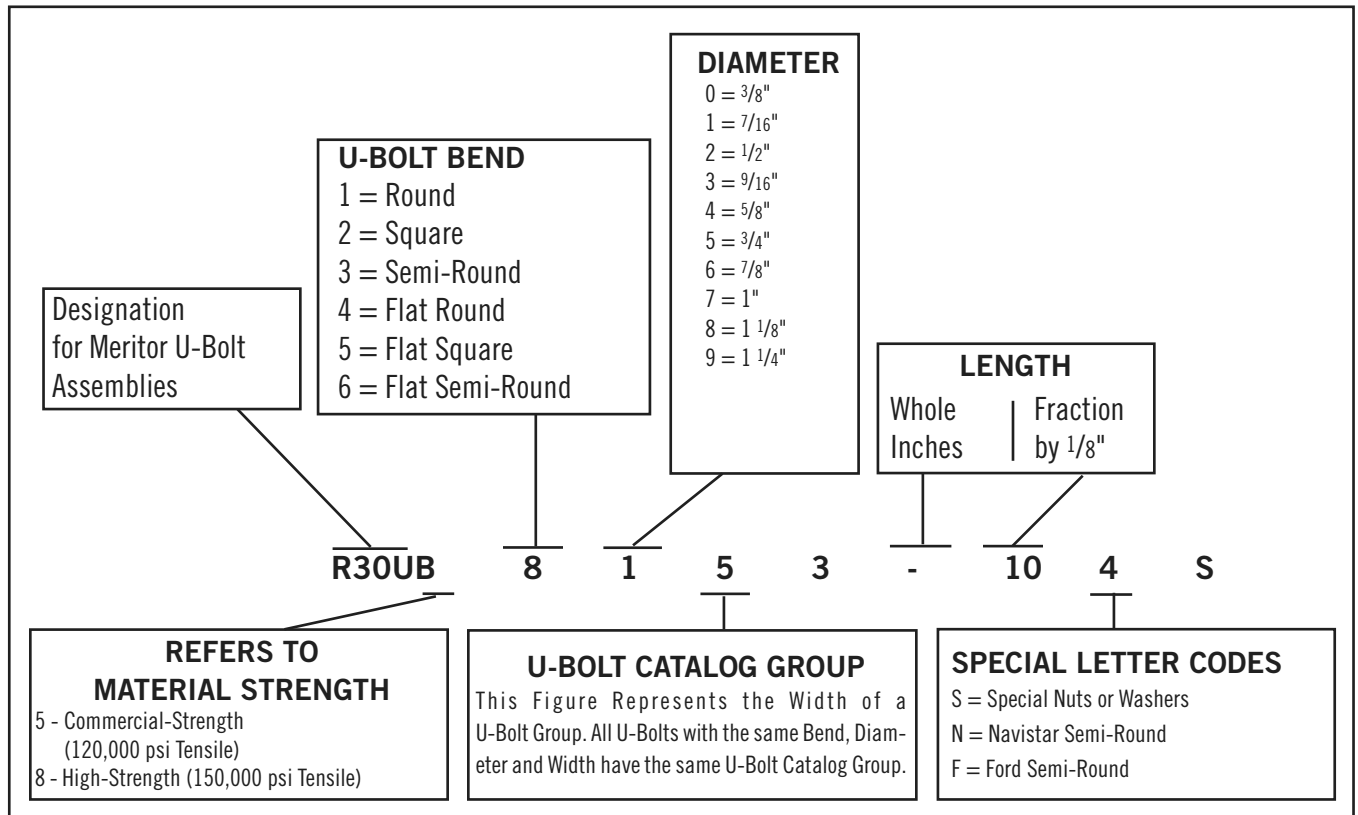

THREADED RODS & U-BOLT ASSEMBLIES

Commercial-Strength Threaded Rod



TOTAL LENGTH	THREAD LENGTH (NOMINAL)	THREAD SIZE		TO DETERMINE REQUIRED THREADED ROD																				
		1/2" - 20	9/16" - 18																					
8"	2 1/4"	R30TR5050-08	—	<ol style="list-style-type: none"> 1. Multiply U-Bolt Leg Length x 2 2. Add U-Bolt Width 3. a. If Round Bend, subtract U-Bolt diameter b. If Square Bend, add U-Bolt diameter c. If Semi-Round Bend, disregard U-Bolt diameter 4. If length is an odd size, use the next longer length rod. <p>Example: For a 7/8" Diameter, 18" Long, 3 1/2" Wide Round Bend U-Bolt, the correct length rod is:</p> <table style="margin-left: 40px;"> <tr> <td></td> <td></td> <td style="text-align: right;">36"</td> <td>(18" Long x 2)</td> </tr> <tr> <td>Plus</td> <td>+</td> <td style="text-align: right;">3.5"</td> <td>(3 1/2" Wide)</td> </tr> <tr> <td>Minus</td> <td>-</td> <td style="text-align: right;">0.875"</td> <td>(Subtract 7/8" Dia., Round Bend)</td> </tr> <tr> <td colspan="4">Rod Length = 38.625"</td> </tr> <tr> <td colspan="4">USE ROD LENGTH 40" (38.625" Rounded up to the next length.)</td> </tr> </table>			36"	(18" Long x 2)	Plus	+	3.5"	(3 1/2" Wide)	Minus	-	0.875"	(Subtract 7/8" Dia., Round Bend)	Rod Length = 38.625"				USE ROD LENGTH 40" (38.625" Rounded up to the next length.)			
		36"	(18" Long x 2)																					
Plus	+	3.5"	(3 1/2" Wide)																					
Minus	-	0.875"	(Subtract 7/8" Dia., Round Bend)																					
Rod Length = 38.625"																								
USE ROD LENGTH 40" (38.625" Rounded up to the next length.)																								
10"	2 1/4"	R30TR5050-10	R30TR5056-10																					
12"	2 1/4"	R30TR5050-12	R30TR5056-12																					
14"	3 1/4"	R30TR5050-14	R30TR5056-14																					
16"	3 1/4"	R30TR5050-16	R30TR5056-16																					
18"	3 1/4"	R30TR5050-18	R30TR5056-18																					
20"	3 1/4"	R30TR5050-20	R30TR5056-20																					
22"	3 1/4"	R30TR5050-22	R30TR5056-22																					
24"	4"	R30TR5050-24	R30TR5056-24																					
26"	4"	R30TR5050-26	R30TR5056-26																					
28"	4"	R30TR5050-28	R30TR5056-28																					
30"	4"	R30TR5050-30	R30TR5056-30																					
32"	4"	R30TR5050-32	R30TR5056-32																					
34"	4"	R30TR5050-34	R30TR5056-34																					
36"	4"	R30TR5050-36	R30TR5056-36																					
38"	4"	—	R30TR5056-38																					
40"	4"	—	R30TR5056-40																					
42"	4"	—	R30TR5056-42																					

THREADED RODS & U-BOLT ASSEMBLIES

NOTE: Commercial-Strength and High-Strength have often been referred to as Grade 5 (120,000 psi tensile strength) and Grade 8 (150,000 psi tensile strength) respectively. These designations do not define manufacturing processes.

Meritor High-Strength Threaded Rod



TOTAL LENGTH	THREAD LENGTH (NOMINAL)	THREAD SIZE					
		5/8" - 18	3/4" - 16	7/8" - 14	1" - 14	1 1/8" - 12	1 1/4" - 12
12"	2 1/4"	R30TR8062-12	R30TR8075-12	—	—	—	—
14"	3 1/4"	R30TR8062-14	R30TR8075-14	—	—	—	—
16"	3 1/4"	R30TR8062-16	R30TR8075-16	—	R30TR8100-16	—	—
18"	3 1/4"	R30TR8062-18	R30TR8075-18	R30TR8087-18	—	—	—
20"	3 1/4"	R30TR8062-20	R30TR8075-20	R30TR8087-20	R30TR8100-20	—	—
22"	3 1/4"	R30TR8062-22	R30TR8075-22	R30TR8087-22	—	—	—
24"	6"	R30TR8062-24	R30TR8075-24	R30TR8087-24	R30TR8100-24	—	—
26"	6"	R30TR8062-26	R30TR8075-26	R30TR8087-26	—	—	—
28"	6"	R30TR8062-28	R30TR8075-28	R30TR8087-28	R30TR8100-28	—	—
30"	6"	R30TR8062-30	R30TR8075-30	R30TR8087-30	—	R30TR8112-30	R30TR8125-30
32"	6"	R30TR8062-32	R30TR8075-32	R30TR8087-32	R30TR8100-32	R30TR8112-32	R30TR8125-32
34"	6"	R30TR8062-34	R30TR8075-34	R30TR8087-34	—	R30TR8112-34	R30TR8125-34
36"	6"	R30TR8062-36	R30TR8075-36	R30TR8087-36	R30TR8100-36	R30TR8112-36	R30TR8125-36
38"	6"	R30TR8062-38	R30TR8075-38	R30TR8087-38	—	R30TR8112-38	R30TR8125-38
40"	6"	R30TR8062-40	R30TR8075-40	R30TR8087-40	R30TR8100-40	—	—
42"	6"	R30TR8062-42	R30TR8075-42	R30TR8087-42	—	—	—
44"	6"	R30TR8062-44	R30TR8075-44	R30TR8087-44	R30TR8100-44	—	—
46"	6"	R30TR8062-46	R30TR8075-46	R30TR8087-46	—	—	—
48"	6"	R30TR8062-48	R30TR8075-48	R30TR8087-48	R30TR8100-48	—	—
50"	6"	—	R30TR8075-50	R30TR8087-50	—	—	—
52"	6"	—	R30TR8075-52	R30TR8087-52	—	—	—

THREADED RODS & U-BOLT ASSEMBLIES

NOTE: Commercial-Strength and High-Strength have often been referred to as Grade 5 (120,000 psi tensile strength) and Grade 8 (150,000 psi tensile strength) respectively. These designations do not define manufacturing processes.

U-BOLT ASSEMBLIES

Includes Nuts and Washers

High-Strength Round Bend U-Bolt Assemblies

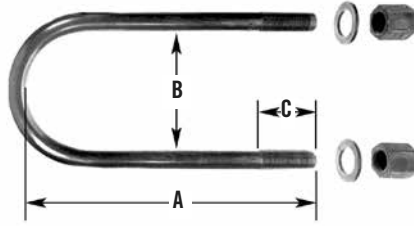

PART NO.	THREAD SIZE	A	B	C	INCLUDES NUT	INCLUDES WASHER	SPECIAL APPLICATION
R30U8142-06	5/8" - 18	6"	3-1/8"	2"	R303000	R302547	Volvo T-Ride
R30U8142-074	5/8" - 18	7-1/2"	3-1/8"	2"	R303000	R302547	Volvo T-Ride
R30U8143-074	5/8" - 18	7-1/2"	3-1/2"	3"	R303000	R302547	Freightliner
R30U8145-076	5/8" - 18	7-3/4"	5"	3-1/2"	R303000	R302547	Neway
R30U8151-10	3/4" - 16	10"	3"	3"	R303001	R302545	-
R30U8151-12	3/4" - 16	12"	3"	3"	R303001	R302545	-
R30U8151-14	3/4" - 16	14"	3"	6"	R303001	R302545	-
R30U8151-16	3/4" - 16	16"	3"	6"	R303001	R302545	-
R30U8151-18	3/4" - 16	18"	3"	6"	R303001	R302545	-
R30U8151-22	3/4" - 16	22"	3"	6"	R303001	R302545	-
R30U8153-10	3/4" - 16	10"	3-1/2"	3"	R303001	R302545	-
R30U8153-12	3/4" - 16	12"	3-1/2"	3"	R303001	R302545	-
R30U8153-14	3/4" - 16	14"	3-1/2"	6"	R303001	R302545	-
R30U8153-18	3/4" - 16	18"	3-1/2"	6"	R303001	R302545	-
R30U8154-10	3/4" - 16	10"	4"	3"	R303001	R302545	Freightliner
R30U8154-12	3/4" - 16	12"	4"	3"	R303001	R302545	-
R30U8154-18	3/4" - 16	18"	4"	6"	R303001	R302545	-
R30U8155-073	3/4" - 16	7-1/2"	5"	3"	R303001	R302545	Hutchens
R30U8155-12	3/4" - 16	12"	5"	3"	R303001	R302545	-
R30U8155-14	3/4" - 16	14"	5"	6"	R303001	R302545	-
R30U8155-16	3/4" - 16	16"	5"	6"	R303001	R302545	-
R30U8156-08	3/4" - 16	8"	5 3/4"	3"	R303001	R302545	Hutchens
R30U8157-08	3/4" - 16	8"	6"	3"	R303001	R302545	Hutchens
R30U8161-10	7/8" - 14	10"	3"	3"	R303002A	R302546	-
R30U8161-11	7/8" - 14	11"	3"	3"	R303002A	R302546	-
R30U8161-12	7/8" - 14	12"	3"	3"	R303002A	R302546	-
R30U8161-122	7/8" - 14	12-1/4"	3"	6"	R303002A	R302546	-
R30U8161-13	7/8" - 14	13"	3"	6"	R303002A	R302546	-
R30U8161-14	7/8" - 14	14"	3"	6"	R303002A	R302546	-
R30U8161-15	7/8" - 14	15"	3"	6"	R303002A	R302546	-
R30U8161-16	7/8" - 14	16"	3"	6"	R303002A	R302546	-
R30U8161-17	7/8" - 14	17"	3"	6"	R303002A	R302546	-
R30U8161-18	7/8" - 14	18"	3"	6"	R303002A	R302546	-
R30U8161-15S1	7/8" - 14	15"	3"	6"	R303002A	R301834/ R303738 Cone washer	Hendrickson

NOTE: Commercial-Strength and High-Strength have often been referred to as Grade 5 (120,000 psi tensile strength) and Grade 8 (150,000 psi tensile strength) respectively. These designations do not define manufacturing processes.

U-BOLT ASSEMBLIES

Suspension

Includes Nuts and Washers

High-Strength Round Bend U-Bolt Assemblies

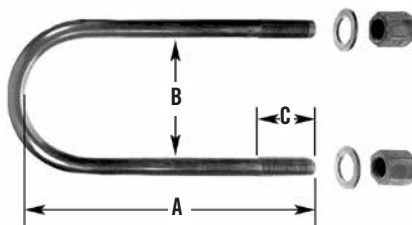

PART NO.	THREAD SIZE	A	B	C	INCLUDES NUT	INCLUDES WASHER	SPECIAL APPLICATION
R30U8161-18S1	7/8" - 14	18"	3"	6"	R303002A	R301834/ R303738 Cone washer	Hendrickson
R30U8161-20	7/8" - 14	20"	3"	6"	R303002A	R302546	-
R30U8161-22	7/8" - 14	22"	3"	6"	R303002A	R302546	-
R30U8162-18	7/8" - 14	18"	3-1/8"	6"	R303002A	R302546	-
R30U8162-22	7/8" - 14	22"	3-1/8"	6"	R303002A	R302546	-
R30U8163-14	7/8" - 14	14"	3-1/2"	6"	R303002A	R302546	-
R30U8163-16	7/8" - 14	16"	3-1/2"	6"	R303002A	R302546	-
R30U8164-10	7/8" - 14	10"	4"	3"	R303002A	R302546	-
R30U8164-12	7/8" - 14	12"	4"	3"	R303002A	R302546	-
R30U8164-16	7/8" - 14	16"	4"	6"	R303002A	R302546	-
R30U8164-18	7/8" - 14	18"	4"	6"	R303002A	R302546	-
R30U8165-076	7/8" - 14	7-3/4"	5"	3"	R303002A	R302546	Hendrickson
R30U8165-10	7/8" - 14	10"	5"	3"	R303002A	R302546	-
R30U8165-12	7/8" - 14	12"	5"	3"	R303002A	R302546	-
R30U8165-13	7/8" - 14	13"	5"	4"	R303002A	R302546	-
R30U8165-14	7/8" - 14	14"	5"	4"	R303002A	R302546	-
R30U8165-16	7/8" - 14	16"	5"	6"	R303002A	R302546	-
R30U8165-18	7/8" - 14	18"	5"	6"	R303002A	R302546	-
R30U8166-12	7/8" - 9	12"	5"	3"	R302983	R302546	Neway
R30U8169-156	7/8" - 14	15-3/4"	5-1/2"	6"	R303002A	R302546	-
R30U8169-166	7/8" - 14	16-3/4"	5-1/2"	6"	R303002A	R302546	-
R30U8168-082	7/8" - 14	8-1/4"	6"	3-5/8"	R303002A	R302546	Hendrickson
R30U8168-082H	7/8" - 14	8-1/4"	6"	3-5/8"	R303002A	R302546	Hendrickson w/ Clearance Flats
R30U8175-104	1" - 14	10-1/2"	5"	3-1/2"	R302892	—	Hutchens
R30U8176-114	1" - 14	11-1/2"	6"	4"	R303003	R302546	Hutchens
R30U8177-114	1" - 14	11-1/2"	5 3/4"	4"	R303003	R302546	Hutchens
R30U8178-126	1" - 14	12-3/4"	5"	6"	R303003	N.S.S.	Neway
R30U8179-09	1" - 14	9"	6-3/8"	3"	R303003	N.S.S.	-
R30U8186-154	1-1/8" - 12	15-1/2"	5-3/4"	6"	R303004	R302548	-
R30U8187-154	1-1/8" - 12	15-1/2"	5-7/8"	6"	R303004	R302548	Hutchens
R30U8187-164	1-1/8" - 12	15-1/2"	5-7/8"	6"	R303004	R302548	Hutchens

**THREADED RODS &
U-BOLT ASSEMBLIES**

NOTE: Commercial-Strength and High-Strength have often been referred to as Grade 5 (120,000 psi tensile strength) and Grade 8 (150,000 psi tensile strength) respectively. These designations do not define manufacturing processes.

U-BOLT ASSEMBLIES

Includes Nuts and Washers

Commercial-Strength Round Bend U-Bolt Assemblies

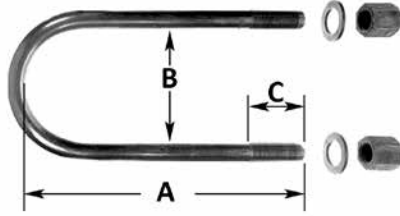

PART NO.	THREAD SIZE	A	B	C	INCLUDES NUT	INCLUDES WASHER	SPECIAL APPLICATION
R30U5161-22	7/8" - 9	22"	3"	6"	R302983	R302546	-
R30U5161-12	7/8" - 14	12"	3"	4"	R303002A	R302546	-
R30U5161-13	7/8" - 14	13"	3"	4"	R303002A	R302546	-
R30U5161-14	7/8" - 14	14"	3"	4"	R303002A	R302546	-
R30U5161-15	7/8" - 14	15"	3"	6"	R303002A	R302546	-
R30U5161-16	7/8" - 14	16"	3"	6"	R303002A	R302546	-
R30U5161-18	7/8" - 14	18"	3"	6"	R303002A	R302546	-
R30U5163-14	7/8" - 14	14"	3-1/2"	6"	R303002A	R302546	-
R30U5163-18	7/8" - 14	18"	3-1/2"	6"	R303002A	R302546	-
R30U5165-12	7/8" - 14	12"	5"	6"	R303002A	R302546	-
R30U5165-14	7/8" - 14	14"	5"	6"	R303002A	R302546	-
R30U5165-15	7/8" - 14	15"	5"	6"	R303002A	R302546	-
R30U5165-16	7/8" - 14	16"	5"	6"	R303002A	R302546	-
R30U5165-18	7/8" - 14	18"	5"	6"	R303002A	R302546	-

THREADED RODS & U-BOLT ASSEMBLIES

NOTE: Commercial-Strength and High-Strength have often been referred to as Grade 5 (120,000 psi tensile strength) and Grade 8 (150,000 psi tensile strength) respectively. These designations do not define manufacturing processes.

U-BOLT ASSEMBLIES

Suspension

Includes Nuts and Washers

High-Strength Square Bend U-Bolt Assemblies

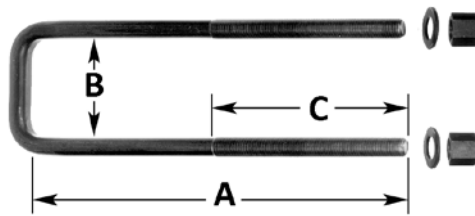

PART NO.	THREAD SIZE	A	B	C	INCLUDES NUT	INCLUDES WASHER	SPECIAL APPLICATION
R30U8253-05	3/4" - 16	5"	3-1/2"	2"	R303001	R302545	Peterbilt
R30U8253-12	3/4" - 16	12"	3-1/2"	3"	R303001	R302545	-
R30U8254-10	3/4" - 16	10"	4"	3"	R303001	R302545	-
R30U8254-12	3/4" - 16	12"	4"	3"	R303001	R302545	-
R30U8254-14	3/4" - 16	14"	4"	6"	R303001	R302545	-
R30U8255-05	3/4" - 16	5"	4"	2"	R303001	R302545	Peterbilt
R30U8257-11	3/4" - 16	11"	6-3/8"	3"	R303001	R302545	Hendrickson
R30U8257-087	3/4" - 16	8-7/8"	6-3/8"	3"	R303001	R302545	Hendrickson
R30U8257-12	3/4" - 16	12"	6-3/8"	3"	R303001	R302545	Hendrickson
R30U8256-077	3/4" - 16	7-7/8"	5"	3"	R303001	R302545	Hutchens
R30U8261-18	7/8" - 14	18"	3"	6"	R303002A	R302546	-
R30U8263-14	7/8" - 14	14"	3-1/2"	6"	R303002A	R302546	-
R30U8264-083	7/8" - 14	8-3/8"	4"	2-1/4"	R301835	R301834	Hendrickson
R30U8264-10	7/8" - 14	10"	4"	3"	R303002A	R302546	-
R30U8264-12	7/8" - 14	12"	4"	3"	R303002A	R302546	-
R30U8264-14	7/8" - 14	14"	4"	6"	R303002A	R302546	-
R30U8264-16	7/8" - 14	16"	4"	6"	R303002A	R302546	Kenworth
R30U8265-084	7/8" - 14	8-1/2"	5"	3-3/4"	R303002A	R302546	Hendrickson
R30U8265-16	7/8" - 14	16"	5"	6"	R303002A	R302546	-
R30U8268-105	7/8" - 14	10 5/8"	5-1/8"	3"	R303002A	R302546	Hutchens
R30U8268-134	7/8" - 14	13-1/2"	5-1/8"	6"	R303002A	R302546	Kenworth
R30U8267-153	7/8" - 14	15-3/8"	5-3/16"	3-1/2"	R303002A	R302546	Freightliner
R30U8271-104	1" - 14	10-1/2"	5"	3"	R303003	R302575	Hutchens
R30U8271-111	1" - 14	11-1/8"	5"	3"	R303003	R302575	Hutchens
R30U8286-134	1-1/8" - 12	13-1/2"	5-1/8"	4"	R303004	R302548	-
R30U8286-154	1-1/8" - 12	15-1/2"	5-1/8"	6"	R303004	R302548	-
R30U8287-11	1-1/8" - 12	11"	5-3/4"	3"	R303004	R302548	Neway
R30U8287-14	1-1/8" - 12	14"	5-3/4"	6"	R303004	R302548	-
R30U8294-162	1-1/4" - 12	16-1/4"	4"	3-1/2"	R303006	R302934	Mack
R30U8294-18	1-1/4" - 12	18"	4"	3-1/2"	R303006	R302934	-
R30U8294-184S	1-1/4" - 12	18-1/2"	4"	3-1/2"	R303005	R302934	-

THREADED RODS & U-BOLT ASSEMBLIES

NOTE: Commercial-Strength and High-Strength have often been referred to as Grade 5 (120,000 psi tensile strength) and Grade 8 (150,000 psi tensile strength) respectively. These designations do not define manufacturing processes.

U-BOLT ASSEMBLIES

Includes Nuts and Washers

Commercial-Strength Square Bend U-Bolt Assemblies

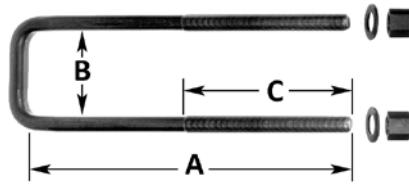

MERITOR NO.	THREAD SIZE	A	B	C	INCLUDES NUT	INCLUDES WASHER	SPECIAL APPLICATION
R30U5243-16	5/8" - 18	16"	3-1/2"	6"	R303000	R302547	Use U-Bolt Plate R309613
R30U5243-18	5/8" - 18	18"	3-1/2"	6"	R303000	R302547	Use U-Bolt Plate R309613
R30U5243-20	5/8" - 18	20"	3-1/2"	6"	R303000	R302547	Use U-Bolt Plate R309613
R30U5244-16	5/8" - 18	16"	4"	6"	R303000	R302547	Use U-Bolt Plate R309614
R30U5244-18	5/8" - 18	18"	4"	6"	R303000	R302547	Use U-Bolt Plate R309614
R30U5244-20	5/8" - 18	20"	4"	6"	R303000	R302547	Use U-Bolt Plate R309614
R30U5261-18	7/8" - 14	18"	3"	6"	R303002A	R302546	-
R30U5263-14	7/8" - 14	14"	3-1/2"	6"	R303002A	R302546	-
R30U5263-18	7/8" - 14	18"	3-1/2"	6"	R303002A	R302546	-

THREADED RODS & U-BOLT ASSEMBLIES

Body Mounting Plate

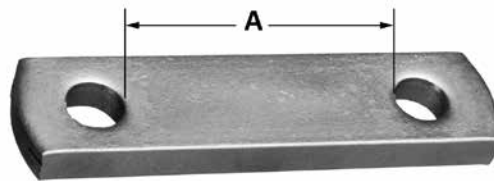

MERITOR NO.	DIAMETER	A	THICKNESS	SPECIAL APPLICATION
R309613	5/8"	3 1/2"	1/2"	Body Mounting Plate used with 5/8" U-Bolt and 5/8" Threaded Rod
R309614	5/8"	4"		

NOTE: Commercial-Strength and High-Strength have often been referred to as Grade 5 (120,000 psi tensile strength) and Grade 8 (150,000 psi tensile strength) respectively. These designations do not define manufacturing processes.

U-BOLT ASSEMBLIES

Suspension

Includes Nuts and Washers

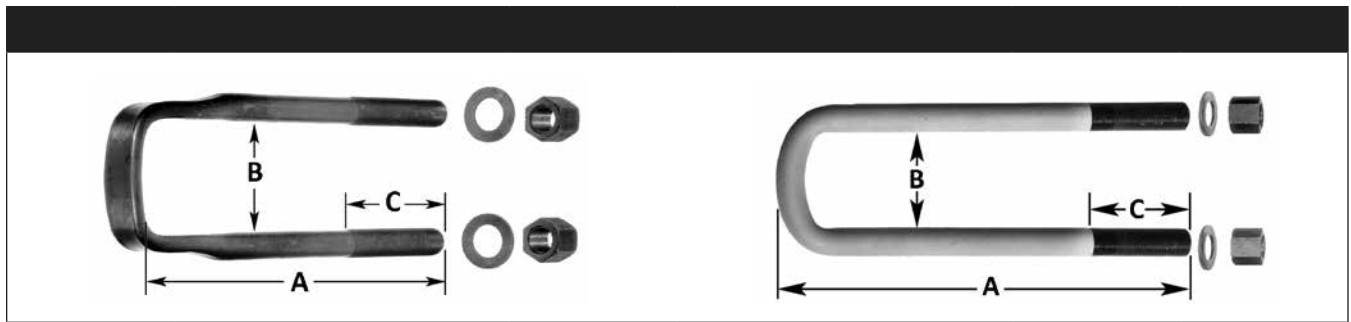

FLAT SEMI-ROUND BEND

SEMI-ROUND BEND

MERITOR NO.	THREAD SIZE	A	B	C	INCLUDES NUT	INCLUDES WASHER	SPECIAL APPLICATION
High-Strength Flat Semi-Round Bend U-Bolt Assemblies							
R30U8673-154	1" - 14	15-1/2"	3-9/16"	5"	R303003	R302975	Peterbilt

High-Strength Semi-Round Bend U-Bolt Assemblies

MERITOR NO.	THREAD SIZE	A	B	C	BEND RADIUS	CORNER RADIUS	INCLUDES NUT	INCLUDES WASHER	SPECIAL APPLICATION
R30U8351-18	3/4" - 16	18"	3"	6"	6"	.750"	R303001	R302545	Navistar
R30U8353-10	3/4" - 16	10"	3-1/2"	3"	4-5/8"	.750"	R303001	R302545	Peterbilt
R30U8353-12	3/4" - 16	12"	3-1/2"	6"	4-5/8"	.750"	R303001	R302545	Peterbilt
R30U8353-15	3/4" - 16	15"	3-1/2"	6"	4"	.625"	R303001	R302545	Navistar
R30U8354-10	3/4" - 16	10"	4"	3"	6"	.500"	R303001	R302545	Kenworth
R30U8354-12	3/4" - 16	12"	4"	3"	5"	.500"	R303001	R302545	-
R30U8354-12P	3/4" - 16	12"	4"	6"	7-1/2"	.656"	R303001	R302545	Peterbilt
R30U8362-19F	7/8" - 14	19"	3-1/16"	7"	3-1/4"	.500"	R303002A	R302546	Ford
R30U8363-15N	7/8" - 14	15"	3-1/2"	6"	4"	.625"	R303002A	R302546	Navistar
R30U8375-14	1" - 14	14"	4-1/8"	3"	5"	.500"	R303003	R302975	Peterbilt
R30U8375-154	1" - 14	15-1/2"	4-1/8"	3"	5"	.500"	R303003	R302975	Peterbilt
R30U8394-144	1-1/4" - 12	14-1/2"	4"	3-1/2"	4"	1.00"	R303006	R302934	Mack
R30U8394-162S	1-1/4" - 12	16-1/4"	4"	3-1/2"	4"	1.00"	R303005	R302934	Mack
R30U8394-172S	1-1/4" - 12	17-1/4"	4"	3-1/2"	4"	1.00"	R303005	R302934	Mack
R30U8394-18	1-1/4" - 12	18"	4"	3-1/2"	4"	1.00"	R303006	R302934	Mack
R30U8394-192S	1-1/4" - 12	19-1/4"	4"	3-1/2"	4"	1.00"	R303005	R302934	Mack
R30U8396-165S	1-1/4" - 12	16-5/8"	5"	3-1/2"	6"	.750"	R303006	R302934	Mack

THREADED RODS & U-BOLT ASSEMBLIES

NOTE: Commercial-Strength and High-Strength have often been referred to as Grade 5 (120,000 psi tensile strength) and Grade 8 (150,000 psi tensile strength) respectively. These designations do not define manufacturing processes.

U-BOLT ASSEMBLIES

Includes Nuts and Washers

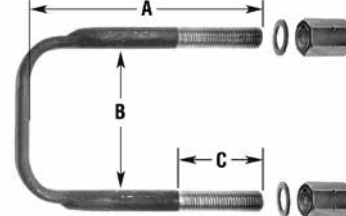
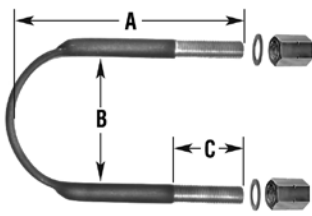

FLAT ROUND BEND

FLAT SQUARE BEND

MERITOR NO.	THREAD SIZE	A	B	C	INCLUDES NUT	INCLUDES WASHER	SPECIAL APPLICATION
High-Strength Flat Round Bend U-Bolt Assemblies							
R30U8466-073H	7/8" - 14	7-3/8"	6"	2-1/2"	R303002A	R302546	Hendrickson Trailer, Stepped Profile, Does Not Require Axle Spacers
R30U8466-082H	7/8" - 14	8-1/4"	6"	2-1/2"	R303002A	R302546	Hendrickson Aux. Axle, Stepped Profile, Does Not Require Axle Spacers
R30U8475-114	1" - 14	11-1/2"	5"	3"	R303003	R302975	Neway
R30U8479-090	1" - 14	9"	6 - 5/16"	2 - 1/4"	R303003	R302975	Neway
R30U8479-104	1" - 14	10-1/2"	6 - 5/16"	3"	R303003	R302975	Neway
R30U8479-124A	1" - 14	12-1/2"	6 - 5/16"	6"	R303003	R302975	Neway

THREADED RODS & U-BOLT ASSEMBLIES

MERITOR NO.	THREAD SIZE	A	B	C	INCLUDES NUT	INCLUDES WASHER	SPECIAL APPLICATION
High-Strength Flat Square Bend U-Bolt Assemblies							
R30U8554-033	3/4" - 16	3 3/8"	4"	1 - 3/4"	R304961A	R302545	Freightliner
R30U8575-126	1" - 14	12-3/4"	5"	4"	R303003	R302975	Fruehauf
R30U8578-094	1" - 14	9-1/2"	6 - 5/16"	3"	R303003	R302975	Neway
R30U8578-124A	1" - 14	12-1/2"	6 - 5/16"	6"	R303003	R302975	Neway
R30U8585-132	1-1/8" - 12	13 - 1/4"	5"	4"	R303004	R302548	Fruehauf

MERITOR NO.	THREAD SIZE	A	B	C	INCLUDES NUT	INCLUDES WASHER	SPECIAL APPLICATION
High-Strength Flat Semi Round Bend U-Bolt Assemblies							
R30U8673-154	1" - 14	15-1/2"	3-9/16"	5"	R303003	R302975	Peterbilt

NOTE: Commercial-Strength and High-Strength have often been referred to as Grade 5 (120,000 psi tensile strength) and Grade 8 (150,000 psi tensile strength) respectively. These designations do not define manufacturing processes.

SPRING CENTER BOLTS

Suspension

Listed By Thread Size (A)

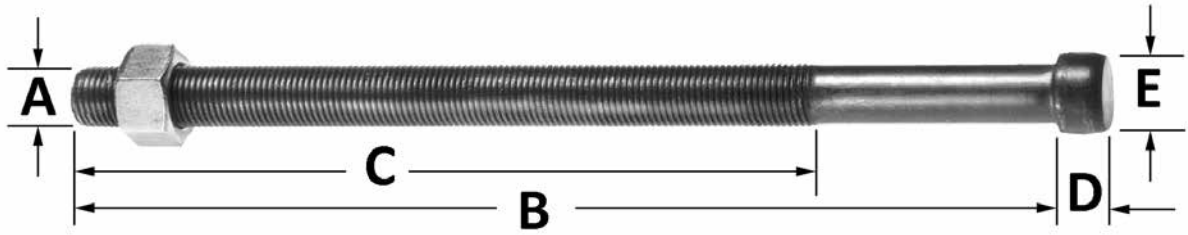

MERITOR NO.	THREAD SIZE (A)	BOLT LENGTH (B)	MINIMUM THREAD LENGTH (C)	HEAD HEIGHT (D)	HEAD DIAMETER (E)
R303188	3/8"-24	8"	6"	3/8"	9/16"
R303189	7/16"-20	8"	5 1/2"	3/8"	5/8"
R303190	7/16"-20	12"	9 1/2"	3/8"	5/8"
R303191	1/2"-20	6"	4"	5/8"	5/8"
R303192	1/2"-20	8"	5 1/2"	3/8"	5/8"
R303193	1/2"-20	8"	5 1/2"	7/16"	3/4"
R303194	1/2"-20	8"	5 1/2"	3/4"	3/4"
R303195	1/2"-20	10"	9 1/2"	5/8"	5/8"
R303196	1/2"-20	12"	9 1/2"	3/8"	5/8"
R303197	1/2"-20	12"	9 1/2"	7/16"	3/4"
R303198	1/2"-20	12"	9 1/2"	3/4"	3/4"
R303199A	5/8"-18	18"	9 1/2"	1/2"	7/8"

SPRING CENTER BOLTS

MISCELLANEOUS SUSPENSION BOLTS

GRADE 5 - LISTED BY THREAD SIZE



GRADE 5

MERITOR NO.	THREAD SIZE	BOLT LENGTH	THREAD LENGTH	PRIMARY APPLICATION
R303555	1/2"-20	1 3/4"	1 3/4"	Freightliner
R3016493	1/2"-20	4 1/2"	1 3/4"	Reyco
R301972	1/2"-20	4 3/4"	3/4"	Reyco
R3015312	1/2"-20	5"	1 1/4"	Reyco, Peterbilt
R302022	1/2"-20	5 1/2"	1 1/4"	Freightliner
R3015291	1/2"-20	6"	1 1/4"	Reyco
R304348	5/8"-11	2"	1 1/2"	Hutchens
R303224	5/8"-11	5 1/2"	1 1/2"	Dayton
R303415*	5/8"-18	4 1/2"	1 1/2"	Hutchens
R304836	5/8"-18	5 1/2"	1 1/2"	Reyco
R3015702	5/8"-18	6"	1 3/4"	Hutchens
R307857	5/8"-18	8"	1 3/4"	Peterbilt
R3016593	3/4"-10	3 3/4"	1 3/4"	Neway
R302989	3/4"-10	5"	1 3/4"	Neway
R3015267	3/4"-16	3"	1 3/4"	Reyco
R301204	3/4"-16	5 1/4"	1 3/4"	Trailmobile
R303542	3/4"-16	8 1/2"	2"	Freightliner
R302981	7/8"-9	2 3/4"	2 3/4"	Neway
R303696	7/8"-9	4 1/2"	2"	Mack
R30901	7/8"-9	5 1/2"	1 1/4"	Dayton, Reyco, Spicer, Hendrickson
R304833	7/8"-14	5 1/4"	1 1/2"	Transpro
R303691	7/8"-14	5 1/4"	2"	Mack
R301987	1"-8	2 1/2"	2 1/2"	Reyco, Spicer
R30900	1"-8	6 3/8"	1 3/4"	Reyco, Spicer
R301997	1"-8	7"	1 1/2"	Spicer
R302274	1"-8	8"	2"	Spicer
R302891*	1"-14	5"	1 1/4"	Hutchens, Trailmobile
R303240	1"-14	5 1/2"	2"	Reyco
R304830	1"-14	6 1/2"	1 3/4"	Transpro
R301166	1"-14	6 3/4"	1 1/2"	Reyco
R307533	1 1/8"-7	6 5/8"	1 7/8"	Hutchens
R304361	1 1/8"-7	8 1/2"	2"	Neway
R304364	1 1/8"-7	9 1/4"	2"	Neway
R302951	1 1/4"-7	8 1/8"	1 1/2"	Neway
R302852	1 1/4"-12	8 7/8"	2 1/2"	Reyco

* Grade 2

MISCELLANEOUS SUSPENSION BOLTS

GRADE 8 - LISTED BY THREAD SIZE

Suspension

MISCELLANEOUS
SUSPENSION BOLTS

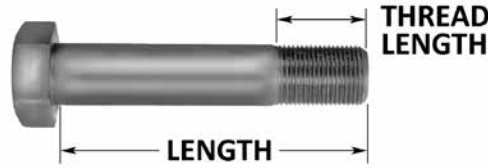

GRADE 8

MERITOR NO.	THREAD SIZE	BOLT LENGTH	THREAD LENGTH	PRIMARY APPLICATION
R3015099	3/8"-16	3 1/2"	1"	Hendrickson
R3015191	7/16"-20	1 1/4"	1 1/4"	Hendrickson
R3015189	1/2"-13	2 1/4"	1 3/4"	Hendrickson
R301820	1/2"-13	6 1/2"	1 1/2"	Hendrickson
R3016232	1/2"-20	3"	1 1/4"	Freightliner
R3016233	1/2"-20	6 1/2"	1 1/2"	Peterbilt
R304348	5/8"-11	2"	1 1/2"	Hutchens
R304759	5/8"-11	2 1/4"	1 1/2"	Peterbilt Flange Head
R3016227	5/8"-11	5"	1 1/2"	Freightliner, Peterbilt, Volvo
R308909	5/8"-11	6"	1 5/8"	Volvo
R308910	5/8"-11	6 5/8"	1 3/4"	Volvo
R3015199	5/8"-11	7"	1 3/4"	Hendrickson, Peterbilt, Volvo
R303792	5/8"-18	4 1/2"	1 1/2"	Navistar
R3016078	5/8"-18	5 1/2"	1 1/2"	Peterbilt
R304345	3/4"-10	3 1/2"	2"	Neway
M301501	3/4"-10	3 1/2"	1 3/4"	Meritor Trailer
M301502	3/4"-10	4 1/2"	1 3/4"	Meritor Trailer
R3015140	3/4"-10	5 1/2"	1 3/4"	Hendrickson, Neway
R3015101	3/4"-10	6"	2"	Hendrickson, Navistar, Neway
R3015102	3/4"-10	8 1/2"	2"	Hendrickson, Navistar, Neway
R3016435	3/4"-10	10"	2"	Hendrickson
R3016436	3/4"-10	11 1/2"	2"	Hendrickson
R3015315	3/4"-16	3"	1 3/4"	Reyco
R3015206	3/4"-16	4 1/2"	1 3/4"	Hutchens
R3015195	3/4"-16	4 3/4"	2 5/8"	-
R3015160	3/4"-16	5"	2 1/4"	Peterbilt
R3015194	3/4"-16	5 1/2"	1 15/16"	Hutchens, Freightliner, Mack
R3015188	3/4"-16	6"	1 3/4"	Hendrickson
R309376	3/4"-16	7"	2"	Granning
R307703	3/4"-16	9"	2"	Freightliner
R3015240	3/4"-16	10"	2"	Reyco
R305272	7/8"-9	4 1/4"	1"	Hendrickson
R3016598	7/8"-9	4 1/2"	2"	Neway
R305427	7/8"-9	6"	2"	Mack
S-21448M-2	7/8"-9	6"	2"	Meritor Trailer

MISCELLANEOUS SUSPENSION BOLTS

GRADE 8 - LISTED BY THREAD SIZE

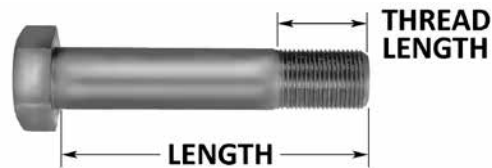

GRADE 8

MERITOR NO.	THREAD SIZE	BOLT LENGTH	THREAD LENGTH	PRIMARY APPLICATION
15-X-1933	7/8"-9	7"	2 1/4"	Meritor Trailer
S-21464-M-2	7/8"-9	8"	2 1/4"	Meritor Trailer
S-21472-M-2	7/8"-9	9"	2 1/4"	Meritor Trailer
S-21488-M-2	7/8"-9	11"	2 1/4"	Meritor Trailer
R3015695	7/8"-14	2 1/2"	2"	Hutchens
R3015286	7/8"-14	3"	2"	Reyco
R303690	7/8"-14	5"	2"	Mack
R3015182	7/8"-14	5 1/2"	2"	Peterbilt
R303692	7/8"-14	6"	2"	Mack
R303693	7/8"-14	6 1/2"	2 1/4"	Mack
R305439	7/8"-14	7 1/2"	2 1/4"	Mack
R303818	7/8"-14	7 3/4"	1 1/2"	Freightliner
R305428	7/8"-14	8"	2 1/4"	Mack
R3015192	1"-8	2 1/4"	2 7/8"	Neway
R301997	1"-8	2 1/2"	1 1/2"	Neway
R303785	1"-8	7 1/2"	2 1/2"	Navistar
R305271	1"-14	7"	2"	Hendrickson
R301073	1"-14	7 1/4"	2 1/2"	Hutchens
R303564	1"-14	8"	1 9/16"	Freightliner
R304778	1"-14	8 1/2"	2 1/2"	Peterbilt
R301860	1"-14	9"	1 7/8"	Hendrickson
R301859	1"-14	9 1/2"	1 7/8"	Hendrickson
R301856	1"-14	10"	1 7/8"	Hendrickson
R301855	1"-14	10 1/4"	1 7/8"	Hendrickson
R309430	1"-14	10 1/2"	1 7/8"	Hendrickson
R302570	1"-14	11"	2"	Hendrickson
R3016600	1 1/8"-7	6 1/2"	2 3/4"	Neway
R304361	1 1/8"-7	8 1/2"	2 3/4"	Neway, Page
R304364	1 1/8"-7	9 1/4"	2 3/4"	Neway

MISCELLANEOUS SUSPENSION NUTS

Suspension

MISCELLANEOUS
SUSPENSION NUTS

Non-Locking				
				
MERITOR NO.	THREAD	HEX	HIGH	PRIMARY APPLICATION
R305032	1/2"-20	3/4"	7/16"	Reyco
R3015184	3/8"-18	9/16"	5/16"	Various
R302002	5/8"-18	15/16"	9/16"	Hutchens, Trailmobile
R301107	3/4"-16	1 1/8"	13/32"	Neway, Trailmobile

Castellated				
				
MERITOR NO.	THREAD	HEX	HIGH	PRIMARY APPLICATION
R302035	1 3/8"-12	2"	15/16"	Hendrickson

Slotted				
				
MERITOR NO.	THREAD	HEX	HIGH	PRIMARY APPLICATION
R301354	1 1/8"-12	1 21/32"	15/16"	Hendrickson

Flange Lock Nut				
				
MERITOR NO.	THREAD	HEX	HIGH	PRIMARY APPLICATION
R3016354	1/2"-13	3/4"	9/16"	Hendrickson
R308911	5/8"-11	15/16"	5/8"	Volvo
R303793	5/8"-18	15/16"	5/8"	Navistar
R3016421	3/4"-16	1 1/8"	7/8"	Hendrickson
R309607	7/8"-14	1 5/16"	3/4"	Reyco
R302892	1"-14	1 1/2"	1"	Hutchens, Trailmobile

Lock Nut - Patch Style				
				
MERITOR NO.	THREAD	HEX	HIGH	PRIMARY APPLICATION
R30937	1"-14	17/16"	7/8"	Fruehauf, Reyco

MISCELLANEOUS SUSPENSION NUTS

MISCELLANEOUS SUSPENSION NUTS

Lock Nut — Nylon Insert



MERITOR NO.	THREAD	HEX	HIGH	PRIMARY APPLICATION
R3016468	1/2"-13	3/4"	5/8"	Hendrickson
R3015094	3/4"-10	1 1/8"	7/8"	Hendrickson
1227-R-1604	7/8"-9	1 5/16"	1"	Meritor Trailer
R304421	1"-8	1 1/2"	1"	Neway
R304779	1"-14	1 7/16"	1 1/32"	Peterbilt
R302079	1 1/8"-12	1 5/8"	1 3/16"	Hendrickson, Kenworth
R302017	1 1/4"-12	1 13/16"	47/64"	Hendrickson
R301946	1 1/2"-12	2 1/4"	13/16"	Hendrickson

Lock Nut — Upset Thread



Type 1

Type 2

Type 3

MERITOR NO.	TYPE	THREAD	HEX	HIGH	PRIMARY APPLICATION
R3016336	1	7/16"-20	1 1/16"	3/8"	Hendrickson
R3016402	1	1/2"-13	3/4"	7/16"	Hendrickson
R303560	1	1/2"-20	3/4"	7/16"	Freightliner, Kenworth
R302988	1	5/8"-11	15/16"	17/32"	Hutchens
R301943	1	5/8"-18	15/16"	9/16"	Hendrickson
R304347	1	3/4"-10	1 1/8"	5/8"	Mack, Neway, Reyco
R304961A	1	3/4"-16	1 1/8"	5/8"	Freightliner, Hendrickson, Reyco
R302983	1	7/8"-9	1 5/16"	13/16"	Neway
R301835	1	7/8"-14	1 5/16"	3/4"	Hendrickson, Mack, Reyco
R304421	1	1"-8	1 1/2"	1"	Neway, Freightliner
R301828	1	1"-14	1 1/2"	7/8"	Hendrickson, Reyco
R304358	1	1 1/8"-7	1 11/16"	15/16"	Neway
R302854	2	1 1/4"-12	1 7/8"	1 1/4"	Neway, Reyco
R304273	3	1 1/4"-7	1 7/8"	12/32"	Neway
R304274	3	1 1/4"-7LH	1 7/8"	23/32"	Neway
R304275	3	1 1/4"-7 RH	1 7/8"	23/32"	Neway
R303298	3	1 5/16"-12	1 3/4"	5/16"	Freightliner
R308841	1	M16-2.0	15/16"	5/8"	Volvo
R3016229	1	M20-2.5	30mm (1 3/16")	16mm (5/8")	Hendrickson, Kenworth, Peterbilt

U-Bolt Hi-Nut

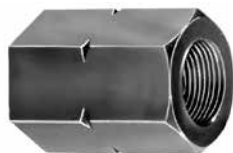

Grade 8

MERITOR NO.	THREAD	HEX	HIGH
R309605*	1/2"-20	3/4"	11/16"
R309606	9/16"-18	7/8"	3/4"
R303000	5/8"-18	1 15/16"	27/32"
R303001	3/4"-16	1 1/16"	1"
R303002A	7/8"-14	1 1/4"	1 5/32"
R303003	1"-14	1 1/2"	1 5/16"
R303004	1 1/8"-12	1 5/8"	1 15/32"
R303005	1 1/4"-12	1 13/16"	1 5/8"
R303006	1 1/4"-12	1 13/16"	2 3/4"

* Grade 5

MISCELLANEOUS SUSPENSION WASHERS

Suspension

Listed by ID



MERITOR NO.	ID	OD	THICKNESS	PRIMARY APPLICATION
R3016399	7/16"	7/8"	1/16"	Hendrickson
R309603	1/2"	1 1/16"	1/8"	Hardened U-Bolt
R309604	9/16"	1 3/16"	1/8"	Hardened U-Bolt
R3015106	5/8"	1 3/4"	1/8"	Hendrickson Airtek
R302547	11/16"	1 5/16"	1/8"	Hardened U-Bolt
R302545	3/4"	1 15/32"	1/8"	Hardened U-Bolt
R309450	3/4"	1 1/4"	3/8"	Page
R301206	3/4"	1 5/8"	15/16"	Trailmobile
R303543	13/16"	2"	1/8"	Freightliner
R3016686	7/8"	1 5/8"	1/8"	Kenworth
M301530	7/8"	1 3/4"	1/4"	Meritor Trailer
R305429	29/32"	1 3/8"	3/16"	Mack
R301834	15/16"	1 1/2"	7/64"	Hendrickson
1229-M-4979	15/16"	2 1/4"	3/16"	Meritor Trailer
R302546	15/16"	1 3/4"	1/8"	Hardened U-Bolt
R309482	15/16"	2 1/4"	1/4"	Hutchens
R302960	1"	SQ 2"	3/8"	Square Washer
R304353	1 1/16"	1 5/8"	1/8"	Neway
R302275	1 1/16"	2"	1/8"	Spicer
R301074	1 1/16"	2 1/2"	1/4"	Fruehauf, Hutchens
R303565	1 1/16"	2 1/2"	5/16"	Freightliner
R30907	1 1/16"	2 3/4"	3/16"	Reyco
R30905	1 1/16"	3 3/4"	1/4"	Reyco
R301986A	1 1/16"	3 3/4"	1/2"	Reyco, Spicer
R301021	1 1/16"	4"	1/4"	Fruehauf
R302573	1 1/8"	1 3/4"	7/64"	Hendrickson
R302975	1 1/8"	2"	5/32"	Hardened U-Bolt
R309454	1 1/8"	2 1/4"	3/8"	Page
R304359	1 1/8"	2 7/8"	1/4"	Spacer Washer
R3016619	1 1/8"	3 1/2"	3/16"	Neway
R3016576	1 1/8"	4"	3/16"	Neway
R304363	1 1/8"	4"	1/4"	Neway
R3016616	1 1/8"	4"	1/4"	Neway
R309452	1 3/16"	1 3/4"	1/8"	Page
G-16641	1 1/4"	1 7/8"	1/32"	Freightliner Spring Pin Shim

MISCELLANEOUS
SUSPENSION WASHERS

MISCELLANEOUS SUSPENSION WASHERS

Listed by ID



MERITOR NO.	ID	OD	THICKNESS	PRIMARY APPLICATION
R302548	1 1/4"	2 1/4"	1/8"	Hardened U-Bolt
G-16642	1 1/4"	2 1/4"	5/32"	Freightliner Spring Pin Shim
R304278	1 1/4"	4"	1/2"	Neway
R3016618	1 1/4"	4 1/2"	1/4"	Neway
R302833	1 5/16"	2 1/2"	1/16"	Fruehauf, Hutchens
R302853	1 5/16"	2 1/4"	3/16"	Reyco
R302934	1 5/16"	2 1/4"	1/4"	Hardened U-Bolt
R302018	1 5/16"	2 1/4"	1/4"	Hendrickson
R3016614	1 7/16"	3 7/16"	5/16"	Neway
R301969	1 1/2"	2 7/16"	3/8"	Reyco
R302956	1 11/16"	3 1/4"	1/8"	Neway
R303297	1 13/16"	2 7/16"	3/16"	Freightliner
R305273	1 29/32"	3 11/16"	1/8"	Hendrickson
R302832	2"	4"	1/16"	Fruehauf
R303541	2 1/4"	3 3/4"	1/16"	Freightliner
R302957	2 9/16"	4"	1/4"	Neway
R304755	2 9/16"	4"	1/4"	Peterbilt
R302958	2 9/16"	4 1/16"	5/32"	Neway
R3015724	2 5/8"	5 1/4"	1/4"	Neway
R304315	3"	4 1/4"	5/16"	Neway
R303699	3 1/2"	5 3/8"	5/16"	Mack
R302959	3 1/2"	5 7/16"	1/4"	Neway
R302021	3 1/2"	5 3/4"	1/8"	Hendrickson
R3015412	3 17/32"	5 1/4"	3/16"	Hutchens
R3015207	4"	5 3/4"	5/32"	Hutchens
R305219	4"	5 3/4"	3/16"	Hutchens
R305423	4"	6 1/4"	5/16"	Mack
R309611	4 1/16"	6"	3/16"	Neway
R309612	4 1/16"	6"	5/16"	Neway

MISCELLANEOUS
SUSPENSION WASHERS

E.S.P. GUIDE

Easy Search for Parts

PURPOSE:

Fleet users do not always know the actual brand of the 4-Spring suspension on their truck or trailer. This problem can often be overcome by visually looking at the style and shape of the equalizer either at the parts counter or with the suspension still installed on the vehicle.

HOW TO USE THIS GUIDE:

The equalizers are arranged on pages 48-49, by overall length and on pages 50 thru 56 by suspension manufacturer then by length.

Simply:

1. Measure overall length and refer to chart on pages 48-49.
2. Measure bushing ID or equalizer shaft OD if required and refer to pages 48-49
3. Refer to photograph on pages 50-56 to visually compare if more than one of same length.
4. Turn to the correct page of the PB-9968 Suspension catalogs to identify bushings, equalizer shaft or other parts required to do a complete suspension repair.

S.O.S. Special Order Service







Can't find it?

Trouble sourcing products?

Need assistance?

Let Meritor's Special Order Service (S.O.S.) help.

Meritor's position as the market leader provides you access to a comprehensive array of truck parts products from the industries leading manufactures. Through Meritor, these entire product lines are available to you just by placing a phone call to Meritor's **S.O.S** Department.

OVERALL LENGTH	SHAFT OD AND BUSHING ID	SUSPENSION MAKE/MODEL	PAGE NO.	EQUALIZER NO.	GENUINE	MACH NO.
13 1/2"	2 1/4"	Freightliner FH36-40	50	R307700	-	G-7700
14"	2"	Dayton/Navistar with 3" Wide Springs	50	R303081	-	-
14 1/4"	1"	Navistar - 3 1/2" Wide Springs	53	R303783	-	-
15"	1"	Binkley SP900 Trailer	50	R309305		G-9305
15 3/4"	1"	Spicer 55	50	R303012	-	-
16"	3/4"	Trailmobile with 3 1/2" Wide Springs	56	R303383	-	-
	1 1/4"	Reyco 100 Series Ford only Pre-1984, One Slot in Bushing	54	R302844	R	G-2844
	1 1/4"	Reyco 100 Series GM/Ford 1984 up, No Slots in Bushing	54	R302845	R	G-2845
	1 1/2"	Reyco 100 Series Standard Pre-1984, Bushing Slots in Both End	54	R302843	R	-
	1 1/2"	Reyco 100 Series Standard Pre-1985, No Slots in Bushing	54	R303978	R	-
	1 1/2"	Reyco 100 Series, No Slots in Bushing	54	R3016494	R	-
	2"	Dayton "Truckmaster"/"Tri-lite"	50	R303080	-	-
	2 1/4"	Freightliner FH34A-44A	50	-	-	G-3917
16 3/8"	2"	Volvo	56	R303844	-	G-3844
	1"	Fruehauf F2, J2, NF-2	50	-	-	G-9366
16 3/8"	2"	Fruehauf F2, J2	50	R308931	-	-
	16 1/2"	3/4"	Hutchens CH-7600/7700, 2-Bolt Cast	52	R302889	-
3/4"		Hutchens CH-7600/7700, 2-Bolt Cast	52	R3016508		-
3/4"		Hutchens H-7600/7700, 2-Bolt Fabricated w/ Wear Plates	51	R302781	-	G-2781
3/4"		Hutchens H-7600/7700 2-Bolt Fabricated	51	R302781A	-	G-2781A
3/4"		Hutchens H-7600/7700 2-Bolt Fabricated	51	R3016392		-
3/4"		Hutchens H-7600/7700, 2-Bolt Fabricated	51	R309570	-	G-9570
3/4"		Hutchens H-7600/7700, 2-Bolt, Fabricated w/ Poly Bushing	51	R307918	-	-
1"		Reyco Transpro 86/88 Fabricated	54	R304813	R	G-4813
1"		Reyco Transpro 88, Cast	54	R3010250	R	G-10250
1 1/8"		Hutchens H-9600/9700, 1-Bolt Fabricated	51	R307532	-	G-7532
1 1/8"		Hutchens H-9600/9700, 1-Bolt Fabricated	51	R3016393		-
1 1/8"		Hutchens H-960/9700, 1-Bolt, Fabricated w/ Poly Bushing	51	R309567	-	-
1 1/8"		Hutchens CH-9600/9700, 1-Bolt Cast	52	R309471	-	G-9471
1 1/8"		Hutchens CH-9600/9700, 1-Bolt Cast	52	R3016507		-
17"	2"	Trailmobile Short Rocker, Obsolete	56	R303398	-	-
	1"	Hendrickson E4-340/360/380/400, Obsolete	51	R305265	-	-
17 1/8"	2"	Fruehauf F2, J2 Fabricated Old Style	51	R302831	-	-
	2 5/8"	Hutchens 2200 Truck/Tractor, Obsolete	52	R302890	-	-
17 1/4"	1"	Peterbilt "Quadraflex"	53	R307869	-	-
17 3/8"	3/4"	Hutchens H-7600/7700, 2-Bolt- 44, 50, 51" Axle Spacing	52	R3015480		-
	1 1/8"	Hutchens H-9600, H-9700, 1-Bolt- 44, 50, 51" Axle Spacing	52	R3011452		-
17 1/2"	1 5/8 "	Reyco 21B-44" Axle Spacing	54	R3010768A	R	-
	2"	Fruehauf F2, F3 Cast	51	R302830	-	-
18"	1 1/4 "	Reyco 83-50" Axle Spacing	55	R307709	R	-
	1 5/8 "	Reyco 21B-49" Axle Spacing, ADI	54	R302846A	R	-
	1 5/8 "	Reyco 21B-49" Axle Spacing, Steel	55	R3016477	R	-

OVERALL LENGTH	SHAFT OD AND BUSHING ID	SUSPENSION MAKE/MODEL	PAGE NO.	EQUALIZER NO.	GENUINE	MACH NO.
19"	1"	Hendrickson HFS-360/400	51	R309402		-
21"	3/4"	Hutchens H-7600/7700, 2-Bolt- 54" Axle Spacing	52	R3015331		-
	1 1/8"	Hutchens H-9600/9700, 1-Bolt- 54" Axle Spacing	52	R3014925		-
	1 1/4"	Reyco 21B Fabricated- 54" Axle Spacing	55	R3016184	R	-
21 3/8"	3/4"	Hutchens H-7600/7700, 2-Bolt- 54 1/2" Axle Spacing	52	R3015338		-
23 1/2"	1 1/8"	Hutchens H-9600/9700, 1-Bolt- 57 1/2" Axle Spacing	53	R3014818		-
24"	1 1/4"	Reyco 74B-54" Axle Spacing	55	R309586	R	-
27"	3/4"	Hutchens H-7600/7700, 2-Bolt- TWS-61" Axle Spacing	53	R3015475		-
	1 1/8"	Hutchens H-9600/9700, 1 Bolt, TWS-61" Spacing	53	R309489		-
27 3/4"	1"	Reyco Transpro 86/88 Series - 60 1/2" Axle Spacing	55	R3016492	R	-
30"	1 1/8"	Hutchens H-9700 TWS-64" Spacing	53	R3015433		-
	1 1/4"	Reyco 21B-60" Axle Spacing	55	R305245	R	-
	1 1/4"	Reyco 21B & Series 83 - 60" Axle Spacing	55	R307710	R	-
30 1/2"	1 1/4"	Reyco 21B & Series 83 - 63 1/2 & 65 1/2" Axle Spacing	55	R3016197	R	-
33"	3/4"	Hutchens H-7600/7700, 2-Bolt- TWS-67" Axle Spacing	53	R3015377		-
	1 1/8"	Hutchens H-9700, 1-Bolt, TWS-67" Spacing	53	R3015430		-
36"	1 1/4"	Reyco 74B -72" Axle Spacing	56	R3015295	R	-
38 1/2"	1 1/8"	Hutchens H/CH9700 TWS-73" Spacing	53	R309330		-
43"	1 1/4"	Reyco 21B Fabricated -72" Axle Spacing	56	R3016198	R	-
	2"	Reyco 21B Cast & Series 73-72" Axle Spacing	56	R305246	R	-
63"	3/4"	Hutchens H-7600/7700, 2-Bolt- TWS-97" Axle Spacing	53	R3015378		-
	1 1/8"	Hutchens H-9700, 1-Bolt, TWS-97" Spacing	53	R3015348		-
75"	3/4"	Hutchens H-7600/7700, 2-Bolt- TWS-109" Axle Spacing	53	R3015379		-
	1 1/8"	Hutchens H-9700, 1-Bolt, TWS-109" Axle Spacing	53	R309491		-
87"	1 1/8"	Hutchens H-9700, 1-Bolt, TWS-121" Axle Spacing	53	R309492		-

EQUALIZERS

Listed By OEM - By Length

Binkley / SAF Holland - SP900 "Duralite"



Fabricated. Includes R304827 / G-4827 Bushing

MERITOR NO.	GENUINE	MACH NO.	OEM REF	LENGTH
R309305		G-9305	SOP0131	15"

Freightliner - FH36-40



Cast. Requires R307701 Bushing Not Included

MERITOR NO.	MACH NO.	OEM REF	LENGTH
R307700	G-7700	681-325-01-27	13 1/2"

Dana - 55 Series (Late)



Cast. Includes R302273 Bushing

MERITOR NO.	OEM REF	LENGTH	NOTES
R303012	B55536	15 3/4"	With Slot In Top of Bushing

Freightliner - FH34A-44A



Cast. Requires R307701, Bushing Not Included

MACH NO.	OEM REF	LENGTH	NOTES
G-3917	16-10175-001	16"	With Brackets. Equalizer Only Is R303917A

Dayton - Navistar



Cast. Includes R303082 Bushing

MERITOR NO.	OEM REF	LENGTH
R303081	377202-C11	14"

Fruehauf - F2



Cast. Requires R301020 Bushings Not Included

MERITOR NO.	OEM REF	LENGTH
R308931	UCF-0006963-001	16 3/8"

Dayton - "Truckmaster", "Tri-Lite"



Cast. Includes R303082 Bushing

MERITOR NO.	OEM REF	LENGTH
R303080	39240007	16"

Fruehauf - NF-2



Cast. Includes G-9368 Bushing

MACH NO.	OEM REF	LENGTH	CASTING NO.	NOTES
G-9366	UCF-008317-001	16 3/8"	6964	One Piece Bushing

EQUALIZERS

EQUALIZERS

Listed By OEM - By Length

Suspension

Fruehauf - F2, J2



Fabricated. Requires R301020 Bushings Not Included

MERITOR NO.	OEM REF	LENGTH
R302831	UCF-001473-001	17"

Fruehauf - F2



Cast. Requires R301020 / G-1020 Bushings Not Included

MERITOR NO.	MACH NO.	OEM REF	LENGTH
R302830	G-2830	UXA-000017	17 1/2"

Hendrickson - E4-340 / 360 / 380 / 400



Cast. Requires R305270 & R305269 Bushings

MERITOR NO.	OEM REF	LENGTH	NOTES
R305265	47444-001	17"	Obsolete

Hendrickson - HFS-360 / 400



Cast. Includes R305269 Bushing

MERITOR NO.	GENUINE	OEM REF	LENGTH	CASTING NO.	NOTES
R309402		49803-002	19"	49801-002	Includes Clevis Pin & Hardware

Hutchens - H-7600 / 7700



Fabricated. Includes Rubber Bushing Unless Otherwise Noted

MERITOR NO.	GENUINE	MACH NO.	OEM REF	NOTES
R3016392		-		Genuine Hutchens
R302781A	-	G-2781A	750-03	Standard Duty
R309570	-	G-9570		Lighter Duty
R302781	-	G-2781	-	Heavy-Duty Side Plates
R307918	-	-	-	Poly Bushing

Hutchens - H-9600 / 9700



Fabricated. Includes Bushing

MERITOR NO.	GENUINE	MACH NO.	OEM REF	NOTES
R3016393		-	16158-01	Rubber Bushing, O.E. Hutchens
R307532	-	G-7532		Rubber Bushing Standard Duty
R309567	-	-	-	Poly Bushing

EQUALIZERS

EQUALIZERS

Listed By OEM - By Length

Hutchens - H / CH-7600 / 7700



Cast. Includes R301999A Bushing

MERITOR NO.	GENUINE	MACH NO.	OEM REF	NOTES
R3016508		-	19137-01	Heavy Duty Option for R3016392 / R302781A
R302889	-	G-2889		

Hutchens - H9600 / 9700



Fabricated. Includes R307621 Bushing

MERITOR NO.	GENUINE	OEM REF	NOTES
R3011452		24711-01	Rubber Bushing; 44", 50", 51" Axle Spacing

Hutchens - H / CH-9600 / 9700



Cast. Includes R307621 Bushing

MERITOR NO.	GENUINE	MACH NO.	OEM REF	NOTES
R3016507		-	17784-01	Heavy Duty Option for R3016393 / R307532
R309471	-	G-9471		

Hutchens - 54" Axle Spacing



Fabricated. Includes Bushing

MERITOR NO.	GENUINE	OEM REF	LENGTH	NOTES
R3015331		12808-01 24821-01	21"	Two Holes R301999A Bushing
R3014925		24820-01		One Hole R307821 Bushing

Hutchens - H-2200



Cast. Requires R302004 Bushings

MERITOR NO.	OEM REF	LENGTH	NOTES
R302890	2224-01	17 1/8"	Obsolete

Hutchens H / CH7600 / 7700



Fabricated. Includes R301999A Bushing

MERITOR NO.	GENUINE	OEM REF	NOTES
R3015480		24712-01	Rubber Bushing 44", 50", 51" Axle Spacing

Hutchens - H7600 / 7700



Fabricated. Includes R301999A Bushing

MERITOR NO.	GENUINE	OEM REF	LENGTH	NOTES
R3015338		24713-01	21 3/8"	54 1/2" Axle Spacing

EQUALIZERS

EQUALIZERS

Listed By OEM - By Length

Suspension

Hutchens - H9600 / 9700







Fabricated. Includes R307621 Bushing

MERITOR NO.	GENUINE	OEM REF	LENGTH	NOTES
R3014818		17604-02 21833-01	23 1/2"	57 1/2" Axle Spacing

Hutchens - H/CH-9700, TWS 109", 121" Widespread







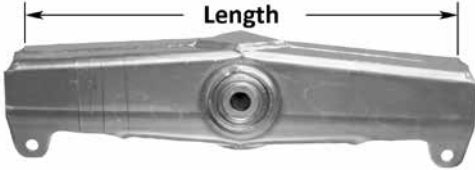

Fabricated.

MERITOR NO.	GENUINE	OEM REF	LENGTH	NOTES
R3015348		16168-09	63"	Includes R307621 Bushing
R3015378		9239-09	63"	Includes R301999A Bushing
R3015379		9239-10	75"	Includes R301999A Bushing
R309491		16168-10	75"	Includes R307821 Bushing
R309492		16168-13	87"	Includes R307821 Bushing

Hutchens H/CH-9700, TWS 61", 73" Widespread



Fabricated

MERITOR NO.	GENUINE	OEM REF	LENGTH	NOTES
R309489		16168-02	27"	Includes R307621 Bushing
R3015475		21841-01	27"	Includes R301999A Bushing
R3015433		16168-15	30"	Includes R307621 Bushing
R3015377		9239-03	33"	Includes R301999A Bushing
R3015430		16168-03	33"	Includes R307621 Bushing
R309330		16168-04	38 1/2"	Includes R307621 Bushing

Navistar Corporate



Cast. Includes R303784 Bushing

MERITOR NO.	OEM REF	LENGTH	NOTES
R303783	497790C2	14 1/4"	Includes R303784 Bushing & R304770 Roller Assembly

Peterbilt "Quadraflex®"



Cast. Requires R307870 Bushing

MERITOR NO.	OEM REF	LENGTH	NOTES
R307869	03-06771M001	17 1/4"	Not Currently Available

EQUALIZERS

EQUALIZERS

Listed By OEM - By Length

Reyco 101, 101A, 102 Series



Cast. Includes Bushings

MERITOR NO.	GENUINE	OEM REF	LENGTH	NOTES
R302843	R	09120-01	16"	R301966 Slotted Bushing, Both Ends
R303978	R	14723-01		R303977 No Slot Bushing

Reyco Transpro - 86 / 88 Series



Fabricated. Includes R304827 Bushing

MERITOR NO.	GENUINE	MACH NO.	OEM REF	LENGTH	NOTES
R304813	R	G-4813	0650-00	16 1/2"	With 1" Bushing ID 49" Axle Spacing

Reyco 101, 101A, 102, 102W Series



Cast. Includes R302849 Bushing

MERITOR NO.	GENUINE	MACH NO.	OEM REF	LENGTH	NOTES
R302844	R	G-2844	08996-01	16"	Ford Pre-1984 (With Slotted Bushing)

Reyco Transpro 86 / 88 Series



Cast. Includes R304827 Bushing

MERITOR NO.	GENUINE	MACH NO.	OEM REF	LENGTH	NOTES
R3010250	R	G-10250	0850-00	16 1/2"	49" Axle Spacing

Reyco 101A, 102, 102W Series



Cast. Includes R302850 Bushing

MERITOR NO.	GENUINE	MACH NO.	OEM REF	LENGTH	NOTES
R302845	R	G-2845	12859-01	16"	GMC All, Ford - 1984 thru current

Reyco - 21B Cast Trailer



Cast. Requires R301159 Bushing Not Included

MERITOR NO.	GENUINE	OEM REF	LENGTH	NOTES
R3010768A	R	25222-01	17 1/2"	42-44" Axle Spacing

Reyco - 101A, 102, 102W Series



Cast. Includes R303977 Rubber Bushing

MERITOR NO.	GENUINE	OEM REF	LENGTH
R3016494	R	14743-01	16"

Reyco - 21B Cast Trailer



Cast. Requires R301159 Bushing Not Included

MERITOR NO.	GENUINE	OEM REF	LENGTH	NOTES
R302846A	R	21725-01	18"	49" Axle Spacing

EQUALIZERS

EQUALIZERS

Listed By OEM - By Length

Suspension

Reyco - 21B Cast Trailer



18"

Cast. Requires R301159 Bushing Not Included

MERITOR NO.	GENUINE	OEM REF	LENGTH
R3016477	R	T-5427	18"

Reyco Transpro 86 / 88 Series



27 3/4"

Fabricated. Includes R304827 Bushings

MERITOR NO.	GENUINE	OEM REF	LENGTH	NOTES
R3016492	R	0841-00	27 3/4"	60 1/2" Axle Spacing

Reyco 21B Fabricated, 83 Series - 50" Widespread



18"

Fabricated. Includes R307713 Bushing

MERITOR NO.	GENUINE	OEM REF	LENGTH
R307709	R	14689-01	18"

Reyco 21B Fabricated, 83" - 60" Series Widespread



30"

Fabricated. Includes R307713 Bushing

MERITOR NO.	GENUINE	OEM REF	LENGTH
R307710	R	14696-01	30"

Reyco 21B Fabricated, 83 Series - 54" Widespread



21"

Fabricated. Includes R307713 Bushing

MERITOR NO.	GENUINE	OEM REF	LENGTH
R3016184	R	14693-01	21"

Reyco 21B Cast - 60" Widespread

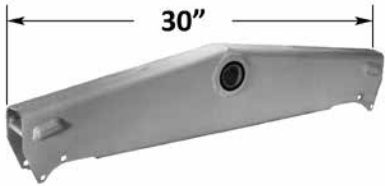

30"

Fabricated. Includes R301160 Bushing

MERITOR NO.	GENUINE	OEM REF	LENGTH
R305245	R	09713-01	30"

Reyco 74B Series - 54" Widespread



24"

Fabricated. Includes R309550 Bushing

MERITOR NO.	GENUINE	OEM REF	LENGTH
R309586	R	13806-01	24"

Reyco 21B Fab., 83 Series, 63 1/2" - 65 1/2" Widespread



30 1/2"

Fabricated. Includes R307713 Bushing

MERITOR NO.	GENUINE	OEM REF	LENGTH
R3016197	R	14700-01	30 1/2"

EQUALIZERS

EQUALIZERS

Listed By OEM - By Length

Reyco 74B - 72" Widespread



Fabricated. Includes R309950 Bushing

MERITOR NO.	GENUINE	OEM REF	LENGTH
R3015295	R	13909-01	36"

Trailmobile



Fabricated. Includes R303394A Bushing

MERITOR NO.	OEM REF	LENGTH	NOTES
R303383	3-A66-43	16"	With 3 1/2" Wide Springs

Reyco 21B Fabricated, 72" Widespread



Fabricated. Includes R307713 Bushing

MERITOR NO.	GENUINE	OEM REF	LENGTH
R3016198	R	14763-01	43"

Trailmobile



Cast. Requires R301072 Bushing

MERITOR NO.	OEM REF	LENGTH	NOTES
R303398	3-A66-42	16 1/2"	Discontinued

Reyco 21B Cast Series & Model 73 - 72" Widespread



Fabricated. Includes R301072 Bushing

MERITOR NO.	GENUINE	OEM REF	LENGTH
R305246	R	11143-01	43"

Volvo Four Spring - Before 1985



Cast. Includes R303082 Bushing



MERITOR NO.	MACH NO.	OEM REF	LENGTH
R303844	G-3844	V8027430; V8061451; 35011-5002	16"

EQUALIZERS

This section shows all of the torque arms (rods) offered by Meritor.

"Easy Search For Parts" (ESP) charts begin on page 58 and show adjustable and rigid torque arms listed by length.

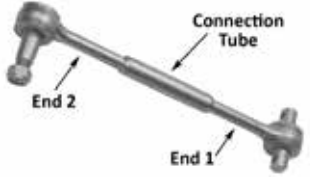
Photographs of adjustable and rigid torque arms are shown starting at page 63 and are listed by OEM

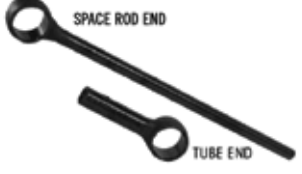
ADJUSTABLE AND RIGID COMPLETE ASSEMBLIES	
	<p>These are available in variety of sizes and bushing styles depending on the application. These torque arms can be found in the parts list or illustrated section for each suspension as well as this components section. While there are many torque arms contained in the Meritor Catalogs, almost any of these one piece torque arms that is not included in this catalog can be ordered through Meritor's S.O.S. program.</p>
TORQUE ARM KITS	
<p>Several different styles of torque arm kits are available from Meritor. These require measurement, cutting to length and welding in the field to produce the required torque arm. This design reduces inventory and provides the maximum flexibility when servicing a fleet customer.</p>	
	<p>UNI-ROD® Kits from ZF Lemforder – These three piece kits offer a full ball socket design which provides for maximum movement or articulation in the suspension. These are typically used for heavy duty trucks and tractors that operate in environments that require high articulation.</p> <p>See Page 78</p>
	<p>Hendrickson ULTRA ROD® - These two piece kits are available from Meritor with a wide variety of bushings to cover virtually every application.</p> <p>See Page 82.</p>
	<p>Hendrickson ULTRA ROD PLUS® - Meritor stocks the empty hub end and empty spacer ends that require Ultra Rod Plus Bushings. Select and install the proper bushings in the field.</p> <p>See Page 85</p>

TORQUE ARMS

TORQUE ARMS

E.S.P. GUIDE

Easy Search for Parts

Adjustable Torque Arms Listed by Center-to-Center Length

HOW TO USE THIS GUIDE:

1. For adjustable torque arms the center of the bushing to the center of the bushing length is the nominal or middle range of the adjustable length.
2. Locate the closest "Center to Center" dimension.
3. Determine which type of end is on the torque arm, cast or fabricated and review the options shown in the "Construction" column.
4. Use the "Primary Application" information to further determine the options for the torque arm.
5. Refer to the photographs beginning on page 63 to visually see the options including details on bushings and bushing kits.



ADJUSTABLE TORQUE ARMS						
NOMINAL CENTER-TO-CENTER LENGTH	CONSTRUCTION	BUSHINGS	PRIMARY APPLICATIONS	MERITOR NO.	MACH NO.	PAGE NO.
13 7/8"	Cast Ends	Bushings Included	Reyco	R307741	-	68
14"	Cast Ends	Bushings Included	Reyco	R309584	-	68
	Fabricated Ends	Bushings Included	Hutchens	R3016390	-	66
15 7/16"	Cast Ends	Bushings Not Included	Fruehauf	R302515	-	64
16"	Cast Ends	Bushings Not Included	Hutchens, Reyco	R302292	-	67, 68
	Cast Ends	Bushings Included	Hutchens	R302510	-	67
	Fabricated Ends	Bushings Included	Hutchens	R303276	-	66
	Fabricated Ends	Bushings Included	Hutchens	R3016527	-	66
16 1/2"	Cast Ends	Bushings Not Included	Reyco	R303283A	-	68
16 1/4"	Cast Ends	Bushings Not Included	Dana	R302294	-	64
16 1/8"	Cast Ends	Bushings Included	Reyco	R3016541	-	68
	Cast Ends	Bushings Included	Dana, Dayton, Hendrickson	R302512	-	64, 65
17"	Fabricated Ends	Hollow Bushings Included	Hutchens, Trailmobile	R303390	G-3390	66, 69
	Fabricated Ends	Bushings Included	Hutchens	R3016396	-	66
18 1/2"	Cast Ends	Bushings Not Included	Hendrickson, Reyco	R303764	-	68
	Cast Ends	Bushings Not Included	Reyco	R303284A	-	68
19 1/4"	Cast Ends	Bushings Not Included	Hutchens	R302293	-	67
	Cast Ends	Bushings Included	Hutchens	R302511	-	67
	Cast Ends	Bushings Not Included	Hutchens, Great Dane	R309476	-	65, 67
	Fabricated Ends	Bushings Included	Hutchens	R3016394	-	66
20"	Cast Ends	Bushings Not Included	Dana	R302295	-	64
	Cast Ends	Bushings Included	Dana, Dayton, Hendrickson, Reyco	R302513	-	64, 65, 68
	Fabricated Ends	Bushings Included	Binkley/SAF Holland, Reyco	R304824	-	63, 68
20 1/2"	Cast Ends	Bushings Not Included	Reyco	R304796	-	68
20 1/4"	Fabricated Ends	Bushings Included	Hutchens	R303277	G-3277	66
	Fabricated Ends	Bushings Included	Hutchens	R307683	-	66
	Fabricated Ends	Bushings Included	Hutchens	R3016528	-	66

TORQUE ARMS

E.S.P. GUIDE

Easy Search for Parts

Adjustable Torque Arms Listed by Center-to-Center Length



ADJUSTABLE TORQUE ARMS

NOMINAL CENTER-TO-CENTER LENGTH	CONSTRUCTION	BUSHINGS	PRIMARY APPLICATIONS	MERITOR NO.	MACH NO.	PAGE NO.
20 5/8"	Cast Ends	Bushings Not Included	Reyco	R307742	-	68
	Cast Ends	Bushings Not Included	Reyco	R302866A	-	68
21"	Cast Ends	Bushings Not Included	Hutchens	R3015429	-	67
21 1/2"	Cast Ends	Bushings Not Included	Chalmers	R304789	-	63
	Fabricated Ends	Bushings Included	Hutchens	R3011448	-	66
	Fabricated End	Bushings Included	Meritor	R3011769	-	67
	Cast Ends	Bushings Not Included	Chalmers	R3014987	-	63
	Fabricated Ends	Bushings Included	Hutchens	R3016526	-	66
21 1/4"	Cast Ends	Bushings Included	Reyco	R309620	-	68
21 3/4"	Cast Ends	Bushings Not Included	Chalmers	R3014773	-	63
22"	Cast Ends	Bushings Not Included	Chalmers	R3014989	-	63
23"	Cast Ends	Bushings Not Included	Chalmers	R3014969	-	63
	Cast Ends	Bushings Included	Volvo	R3016819	-	69
23 1/2"	Fabricated Ends	Bushings Included	Hutchens	R307684	-	66
	Fabricated Ends	Bushings Included	Hutchens	R3016530	-	66
24"	Cast Ends	Bushings Not Included	Chalmers	R304790	-	63
	Cast Ends	Bushings Not Included	Chalmers	R3014976	-	63
24 1/2"	Cast Ends	Bushings Included	Reyco	R3015294	-	68
25"	Cast Ends	Bushings Not Included	Chalmers	R3014774	-	63
	Fabricated Ends	Bushings Included	Hutchens	R3015342	-	66
25 1/8"	Cast Ends	Bushings Included	Trailmobile	R307743	-	68
	Cast Ends	Bushings Not Included	Reyco	R3016495	-	68
	Cast Ends	Bushings Not Included	Reyco	R305255A	-	68
26 1/2"	Fabricated Ends	Bushings Included	Hutchens	R3015344	-	66
28"	Fabricated Ends	Bushings Included	Hutchens	R3015343	-	66
29 1/2"	Fabricated Ends	Bushings Included	Hutchens	R307685	-	66
	Fabricated Ends	Bushings Included	Hutchens	R3016529	-	66
30 3/4"	Fabricated Ends	Bushings Included	Hutchens	R3015346	-	66
33"	Cast Ends	Bushings Not Included	Chalmers	R3014975	-	63
33 1/2"	Fabricated Ends	Bushings Included	Hutchens	R3015353	-	66
34 3/4"	Fabricated Ends	Bushings Included	Hutchens	R3015350	-	66

TORQUE ARMS

TORQUE ARMS

E.S.P. GUIDE

Easy Search for Parts

Rigid Torque Arms Listed by Center-to-Center Length

HOW TO USE THIS GUIDE:

1. Locate the proper "Center to Center" dimension. Since the length of these torque arms cannot be changed, the length's must be matched accurately.
2. Only minor changes to the "length" can be made to some torque arms using shims which are typically used for axle alignment on rear truck axles.
3. Review the various types of "Construction" and "Bushings" shown at the top of the page and "Primary Applications" to determine the proper part number.
4. Refer to the photographs beginning on page 70 to visually see the options including details on bushings and bushing angles where applicable.

TUBULAR CENTER BAR	SOLID CENTER BAR	CAST DESIGN	FABRICATED DESIGN	STRADDLE/BAR PIN	TAPERED PIN	HOLLOW BUSHING
						
Construction Options				Bushing Options		

RIGID TORQUE ARMS

CENTER-TO-CENTER LENGTH	CONSTRUCTION	BUSHINGS	PRIMARY APPLICATIONS	MERITOR NO.	MACH NO.	PAGE NO.
14 1/4"	Cast Center Bar	Hollow Bushings Included	Reyco	R309585	-	76
14 13/32"	Tubular Center Bar	Includes 1- Straddle & 1- Hollow Bushing	Hendrickson	R309394	-	72
	Cast Center Bar	Straddle Bushings Included	Hendrickson	R309409	-	72
14 9/16"	Fabricate Design	Hollow Bushing Included	Neway	R304319	-	75
15"	Cast Center Bar	Hollow Bushings Included	Reyco	R307744	-	76
15 7/16"	Cast Center Bar	Bushings Not Included	Fruehauf	R302514	G-2514	72
15 1/2"	Tubular Center Bar	Includes 1- Straddle & 1- Hollow Bushing	Hendrickson	R303773	-	72
15 11/16"	Cast Center Bar	Straddle Bushings Included	Hendrickson	R3016364	-	72
15 27/32"	Cast Center Bar	Straddle Bushings Included	Hendrickson	R303731	-	72
15 7/8"	Tubular Center Bar	Includes 1- Straddle & 1- Hollow Bushing	Hendrickson	R305282	-	72
	Tubular Center Bar	Bushings Not Included	Chalmers	R3014985	-	70
16 1/4"	Tubular Center Bar	Hollow Bushings Included	Reyco	R302855	-	76
16 5/8"	Tubular Center Bar	Straddle Bushings Included	Freightliner	R308941	G-8941	71
	Tubular Center Bar	Straddle Bushings Included	Freightliner	R309869	-	71
16 3/4"	Cast Center Bar	Hollow Bushings Included	Reyco	R3016540	-	76
17"	Fabricated Design	Bushings Included	Trailmobile	R303391	-	77
17 11/32"	Solid Center Bar	Straddle Bushings Included	Peterbilt	R305082	G-5082	75
	Solid Center Bar	Straddle Bushings Included	Peterbilt	R305083	G-5083	75
18 1/8"	Solid Center Bar	Straddle Bushings Included	Navistar	R303788	-	74
	Tubular Center Bar	Straddle Bushings Included	Navistar	R3010764	-	74
18 3/16"	Tubular Center Bar	Straddle Bushings Included	Freightliner	R303546	G-3546	71
18 7/16"	Tubular Center Bar	Includes 1- Straddle & 1- Hollow Bushing	Peterbilt	R307887	G-7887	75
18 5/8"	Tubular Center Bar	Hollow Bushings Included	Reyco	R302856	-	76
19"	Tubular Center Bar	Includes 1- Straddle & 1- Hollow Bushing	Hendrickson	R303774A-2	-	72
19 1/8"	Tubular Center Bar	Straddle Bushings Included	Peterbilt	R304753	G-4753	75

TORQUE ARMS

E.S.P. GUIDE

Easy Search for Parts

Rigid Torque Arms Listed by Center-to-Center Length

TUBULAR CENTER BAR	SOLID CENTER BAR	CAST DESIGN	FABRICATED DESIGN	STRADDLE/BAR PIN	TAPERED PIN	HOLLOW BUSHING
						
Construction Options				Bushing Options		
RIGID TORQUE ARMS						
CENTER-TO-CENTER LENGTH	CONSTRUCTION	BUSHINGS	PRIMARY APPLICATIONS	MERITOR NO.	MACH NO.	PAGE NO.
19 1/4"	Fabricated Design	Bushings Included	Hutchens	R302899	G-2899	73
	Cast	Bushings Included	Binkley/SAF Holland	R309307	G-9307	70
	Cast Center Bar	Bushings Not Included	Hutchens	R309477	-	73
	Fabricated Design	Bushings Included	Hutchens	R3016395	-	73
19 5/8"	Cast Center Bar	Hollow Bushings Included	Reyco	R304825	-	76
20 5/16"	Cast Center Bar	Straddle Bushings Included	Hendrickson	R309407	-	72
20 1/2"	Tubular Center Bar	Hollow Bushings Included	Reyco	R302860	-	76
21"	Tubular Center Bar	Hollow Bushings Included	Reyco	R302858	-	76
21 1/4"	Cast Center Bar	Hollow Bushings Included	Reyco	R309619	-	76
21 1/2"	Tubular Center Bar	Bushings Not Included	Chalmers	R304791	-	70
	Solid Center Bar	Hollow Bushings Included	Meritor	R3011768	-	74
	Tubular Center Bar	Bushings Not Included	Chalmers	R3014978	-	70
21 3/4"	Tubular Center Bar	Bushings Not Included	Chalmers	R3014990	-	70
21 15/16"	Cast Center Bar	Straddle Bushings Included	Hendrickson	R303732	-	72
	Tubular Center Bar	Includes 1- Straddle & 1- Hollow Bushing	Hendrickson	R305283	-	72
21 31/32"	Solid Center Bar	Straddle Bushings Included	Navistar	R303789	-	74
	Tubular Center Bar	Straddle Bushings Included	Navistar	R3010765	-	74
22"	Tubular Center Bar	Includes 1- Straddle & 1- Hollow Bushing	Hendrickson, Mack	R3013993	-	72, 74
	Tubular Center Bar	Bushings Not Included	Chalmers	R3014991	-	70
22 1/8"	Solid Center Bar	Straddle Bushings Included	Mack/Volvo	R308821	-	77, 74
22 5/8"	Crimped Center Bar Design	Straddle Bushings Included	Volvo	R3016818	-	77
22 15/16"	Tubular Center Bar	Straddle Bushings Included	Freightliner	R308808	-	71
23"	Solid Center Bar	Straddle Bushings Included	Peterbilt	R304771	G-4771	75
	Solid Center Bar	Straddle Bushings Included	Volvo	R308853	-	77
23 1/4"	Crimped Center Bar	Straddle Bushings Included	Freightliner	R3016058	-	71
	Crimped Center Bar	Straddle Bushings Included	Freightliner	R3016059	-	71
23 3/4"	Tubular Center Bar	Includes 1- Straddle & 1- Hollow Bushing	Peterbilt	R3016098	G-16098	75
23 15/16"	Solid Center Bar	Straddle Bushings Included	Freightliner	R3016277	-	71
	Tubular Center Bar	Straddle Bushings Included	Freightliner	R3015536	G-15536	71
24"	Tubular Center Bar	Bushings Not Included	Chalmers	R304792	-	70
	Tubular Center Bar	Bushings Not Included	Chalmers	R3014979	-	70
	Solid Center Bar	Straddle Bushings Included	Kenworth	R3015708	-	73
	Solid Center Bar	Includes 1 Straddle & 1 Tapered Pin Bushing	Kenworth	R3015711	-	73





TORQUE ARMS

TORQUE ARMS

E.S.P. GUIDE

Easy Search for Parts

Rigid Torque Arms Listed by Center-to-Center Length

TUBULAR CENTER BAR	SOLID CENTER BAR	CAST DESIGN	FABRICATED DESIGN	STRADDLE/BAR PIN	TAPERED PIN	HOLLOW BUSHING
						
Construction Options				Bushing Options		
RIGID TORQUE ARMS						
CENTER-TO-CENTER LENGTH	CONSTRUCTION	BUSHINGS	PRIMARY APPLICATIONS	MERITOR NO.	MACH NO.	PAGE NO.
24 1/4"	Cast and Angled Center Bar	Bushings Not Included	Chalmers	R3014986	-	70
24 3/8"	Tubular Center Bar	Straddle Bushings Included	Freightliner	R3015542	-	71
24 7/16"	Crimped Center Bar	Straddle Bushings Included	Freightliner	R3016054	-	71
	Solid Center Bar	1- Straddle & 1- Tapered Pin Bushing Included	Freightliner	R3016653	G-16653	71
24 1/2"	Cast Center Bar	Hollow Bushings Included	Reyco	R3015293	-	76
	Crimped Center Bar	Straddle Bushings Included	Freightliner	R3016055	-	71
25"	Tubular Center Bar	Hollow Bushings Included	Reyco	R305256	-	76
	Solid Center Bar	Straddle Bushings Included	Kenworth	R3015611	-	73
25 1/4"	Cast Center Bar	Hollow Bushings Included	Reyco	R307746	-	76
25 3/8"	Tubular Center Bar	Straddle Bushings Included	Navistar	R3016075	-	74
25 1/2"	Solid Center Bar	Straddle Bushings Included	Peterbilt	R3015709	-	75
25 9/16"	Tubular Center Bar	Straddle Bushings Included	Peterbilt	R3016118	G-16118	75
25 5/8"	Tubular Center Bar	Straddle Bushings Included	Peterbilt	R307853	G-7853	75
26 3/8"	Crimped Center Bar	Straddle Bushings Included	Freightliner	R3016222	-	71
	Crimped Center Bar	Straddle Bushings Included	Freightliner	R3016223	-	71
33"	Tubular Center Bar	Bushings Not Included	Chalmers	R3014977	-	70
34 5/8"	Tubular Center Bar	Includes 1- Straddle & 1- Hollow Bushing	Peterbilt	R3016099	G-16099	75
38"	Cast Center Bar	Hollow Bushings Included	Reyco	R3015266	-	76
44"	Cast Center Bar	Hollow Bushings Included	Reyco	R3015276	-	76

TORQUE ARMS

Adjustable - Listed Alphabetically by OEM

Binkley / SAF-Holland



Includes Bushings

MERITOR NO.	MACH NO.	OEM REF	FOR MODELS	BUSHING NO.	LENGTH
R304824	G-4824	SP0123	Binkley/Duralite	R301980 / G-1980	18-1/2" to 21-1/2"

Chalmers



Bushings Not Included

MERITOR NO.	GENUINE	OEM REF	FOR MODELS	JOINT TYPE	NOMINAL LENGTH	BUSHINGS				NOTES
						STANDARD SIZE RUBBER	STANDARD SIZE POLY	OVERSIZE RUBBER	OVERSIZE POLY	
R304789		216214	300 & 600 Series	0 & 1	21-1/2"	R304677A/G-4677A	R307427	R304678A/G-4678A	-	-
R3014987		807214	800 Series	2	21-1/2"	R307766/G-7766	R307426	R307767/G-7767	R308917	-
R3014773		807250	800 Series	2	21-3/4"	R307766/G-7766	R307426	R307767/G-7767	R308917	46K
R3014989		807220	800 Series	2	22"	R307766/G-7766	R307426	R307767/G-7767	R308917	-
R3014969		216230	300 Series	0	23"	R304677A/G-4677A	R307427	R304678A/G-4678A	-	-
R304790		216240	300, 600 & 700 Series	0 & 1	24"	R304677A/G-4677A	R307427	R304678A/G-4678A	-	-
R3014976		807240	700 & 800 Series	2	24"	R307766/G-7766	R307426	R307767/G-7767	R308917	-
R3014774		807216	800 Series	2	25"	R307766/G-7766	R307426	R307767/G-7767	R308917	46K
R3014975		216330	700 Series	1	33"	R304677A/G-4677A	R307427	R304678A/G-4678A	-	-

TORQUE ARMS

TORQUE ARMS

Adjustable - Listed Alphabetically by OEM

Dana							
 <p style="text-align: center;">TYPE 1</p>				 <p style="text-align: center;">TYPE 2</p>			
MERITOR NO.	OEM REF	FOR MODELS	BUSHING NO.	USES BUSHING KIT	LENGTH	TYPE	NOTES
R302512	M109201	62 & 68 Series	R301980	R301981	14-3/4" to 18"	1	Includes Bushings
R302513	M109202	62 & 68 Series	R301980	R301981	18-1/2" to 21-1/2"	1	Includes Bushings
R302294	M109101	55 Series	R301982	R301983	14" to 18-1/2"	2	Bushings Not Included
R302295	M109102	55 Series	R301982	R301983	18-1/2" to 21-1/2"	2	Bushings Not Included

Dayton							
							
Includes Bushings							
MERITOR NO.	OEM REF	FOR MODELS	BUSHING NO.	USES BUSHING KIT	LENGTH	NOTES	
R302512	39090029	All	R301980	R301981	14-3/4" to 18"	Front	
R302513	39090030	All	R301980	R301981	18-1/2" to 21-1/2"	Rear	

Fruehauf							
							
Does Not Include Bushings							
MERITOR NO.	MACH NO.	OEM REF	FOR MODELS	BUSHING NO.	USES BUSHING KIT	LENGTH	
R302515	G-2515	UCF-002640-001	F-2, J-2, NF-2, NT	R30927 / G-927	R301023 / G-1023	15 7/16"	

TORQUE ARMS

TORQUE ARMS

Adjustable - Listed Alphabetically by OEM

Great Dane



Bushings Not Included

MERITOR NO.	OEM REF	FOR MODELS	BUSHING NO.	USES BUSHING KIT	NOMINAL LENGTH
R309476	16167-04	H	R30927	R309478	19-1/4"

Hendrickson



Includes Bushings

MERITOR NO.	OEM REF	FOR MODELS	BUSHING NO.	USES BUSHING KIT	LENGTH
R302512	S-1032-2	HLQ, Q Series	R301980	R301981	14-3/4" to 18"
R302513	S-1032-1	HLQ, Q Series	R301980	R301981	18-1/2" to 21-1/2"

TORQUE ARMS

TORQUE ARMS

Adjustable - Listed Alphabetically by OEM

Hutchens



FABRICATED ENDS

Includes Bushings

MERITOR NO.	GENUINE	MACH NO.	OEM REF	FOR MODELS	INCLUDES BUSHING NO.	USES BUSHING KIT	NOMINAL LENGTH
R3016390		-	16398-01	H-7700, CH-7700 H-9700, CH-9700	R30934	R303079	14"
R303276	-	-	16398-02 713-02	H-7700, CH-7700 H-9700, CH-9700	R30934	R303079	16"
R3016527		-					
R303390	-	G-3390	16398-17	H-7700, CH-7700 H-9700, CH-9700	R30934	R303079	17"
R3016396		-	16398-17	H-7700, CH-7700 H-9700, CH-9700	R30934	R303079	17"
R3016394		-	16398-04	H-7700, CH-7700 H-9700, CH-9700	R30934	R303079	19 1/4"
R303277	-	G-3277	16398-04	H-7700, CH-7700 H-9700, CH-9700	R30934	R303079	20 1/4"
R307683		-	16398-05	H-7700, CH-7700 H-9700, CH-9700	R30934	R303079	20 1/4"
R3016528							
R3011448	-	-	16398-06	H-7700, CH-7700 H-9700, CH-9700	R30934	R303079	21 1/2"
R3016526		-					
R307684	-	-	16398-08	H-7700, CH-7700 H-9700, CH-9700	R30934	R303079	23 1/2"
R3016530		-					
R3015342		-	16398-09	H-7700, CH-7700 H-9700, CH-9700	R30934	R303079	25"
R3015344		-	16398-10	H-7700, CH-7700 H-9700, CH-9700	R30934	R303079	26 1/2"
R3015343		-	16398-11	H-7700, CH-7700 H-9700, CH-9700	R30934	R303079	28"
R307685	-	-	16398-12	H-7700, CH-7700 H-9700, CH-9700	R30934	R303079	29 1/2"
R3016529		-					
R3015346		-	16398-13	H-7700, CH-7700 H-9700, CH-9700	R30934	R303079	30 3/4"
R3015353		-	16398-14	H-7700, CH-7700 H-9700, CH-9700	R30934	R303079	33 1/2"
R3015350		-	16398-15	H-7700, CH-7700 H-9700, CH-9700	R30934	R303079	34 3/4"

TORQUE ARMS



Adjustable - Listed Alphabetically by OEM

Hutchens



CAST ENDS

Includes Bushings As Noted

MERITOR NO.	GENUINE	MACH NO.	OEM REF	FOR MODELS	INCLUDES BUSHING NO.	USES BUSHING KIT	NOMINAL LENGTH
R302510	-	-	-	H-7700, CH-7700 H-9700, CH-9700	R30934	R303079	16"
R302292	-	-	-	H-7700, CH-7700 H-9700, CH-9700	Not Included. Use R30934	R303079	16"
R302511	-	-	-	H-7700, CH-7700 H-9700, CH-9700	R30934	R303079	19 1/4"
R302293	-	-	-	H-7700, CH-7700 H-9700, CH-9700	Not Included. Use R30934	R303079	19 1/4"
R309476		-	16167-04	H-7600, CH-7600 H-9600, CH-9600	Not Included. Use R30927	R309478	19 1/4"
R3015429		-	16167-06	H-7600, CH-7600 H-9600, CH-9600	Not Included. Use R30927	R309478	21"

Meritor



Includes Poly Bushings

MERITOR NO.	GENUINE	FOR MODELS	BUSHING NO.	LENGTH
A1-3133-Y-8345		RHP / MPA	R3017029	20 1/4" - 22 3/4"

TORQUE ARMS

TORQUE ARMS

Adjustable - Listed Alphabetically by OEM

Reyco Granning



TYPE 1

TYPE 2

MERITOR NO.	GENUINE	MACH NO.	OEM REF	FOR MODELS	INCLUDES BUSHING, HANGER END	INCLUDES BUSHING, AXLE SEAT END	BUSHING ASSEMBLY, HANGER SEAT END	BUSHING ASSEMBLY, AXLE SEAT END	LENGTH	TYPE
R307741	R	-	16031-01	73, 73 WS, 83	R307750	R301980	R307749	R301981	12-3/4" to 15"	1
R309584	R	-	16595-01	74B 72"-109", 74B 50"-60", 74AR	R309549	R309549	R309587	R309587	13" to 15"	2
R3016541	R	-	20138-01	240AR	R3010057	R301980	R309350	R301981	15" to 17-1/4"	1
R303283A	R	-	15172-01	21B Cast, 21B FAB, 21AR	Not Included, Use R301160	Not Included, Use R301160	R301312A	R301312A	15-1/2" to 17-1/2"	1
R303284A	R	-	15173-01	21B Cast, 21B FAB	Not Included, Use R301160	Not Included, Use R301160	R301312A	R301312A	17-1/2" to 19-1/2"	1
R303764	R	-	15187-01	102W, 102AR	Not Included, Use R3010057	Not Included, Use R301980	R309350	R301981	17-1/2" to 19-1/2"	1
R302513	R	-	-	86AR	R301980	R301980	R301981	R301981	18-1/2" to 21-1/2"	2
R304824	R	G-4824	1035-20	86AR, 86-88	R301980	R301980	R304834A	R304834A	18-1/4" to 20-3/4"	1
R304796	R	-	15186-01	102W, 102AR	Not Included, Use R3010057	Not Included, Use R301980	R309350	R301981	19-1/2" to 21-1/2"	1
R302866A	R	-	15354-01	21B FAB, 102	Not Included, Use R3010057	Not Included, Use R301982	R309350	R301983	19-1/2" to 21-3/4"	1
R307742	R	-	16032-01	73, 73 WS, 83	Not Included, Use R307750	Not Included, Use R301980	R307749	R301981	19-1/2" to 21-3/4"	1
R309620	R	-	16596-01	74B 50"-60", 74B 72"-109"	R309549	R309549	R309587	R309587	21-1/4"	2
R305255A	R	-	15176-01	21B FAB, 102	Not Included, Use R3010057	Not Included, Use R301982	R309350	R301983	24" to 26-1/4"	1
R307743	R	-	16034-01	73 WS, 83	R307750	R301980	R307749	R301981	24" to 26-1/4"	1
R3015294	R	-	16597-01	74B 50"-60"	R309549	R309549	R309587	R309587	24-1/2"	2
R302292	-	-	16347-01	102CC	R301980	R301980	R301981	R301981	14-3/4" to 18-1/2"	2
R3016495	R	-	16429-01	102AR	R301980	R301980	R301981	R301981	24" to 26 1/4"	1

TORQUE ARMS

Adjustable - Listed Alphabetically by OEM

Trailmobile



Includes Bushings

MERITOR NO.	MACH NO.	OEM REF	FOR MODELS	BUSHING NO.	USES BUSHING KIT	LENGTH
R303390	G-3390	3-A11-65A	With Fabricated Equalizer	R30934	R303079	17"

Volvo

PHOTO COMING SOON

Includes Bushings

MERITOR NO.	OEM REF	FOR MODELS	LENGTH	TYPE
R3016819	20509568	Volvo T Ride 2006 and Later	23"	Crimped Center Bar Design

TORQUE ARMS

TORQUE ARMS

Rigid - Listed Alphabetically by OEM

Binkley / SAF-Holland

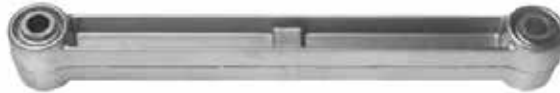

Includes Bushings

MERITOR NO.	MACH NO.	OEM REF	FOR MODELS	BUSHING NO.	LENGTH
R309307	G-9307	SP0143	Binkley/Duralite	R301980 / G-1980	19-1/4"

Chalmers



Bushings Not Included

MERITOR NO.	GENUINE	OEM REF	FOR MODELS	JOINT TYPE	LENGTH	BUSHINGS			
						STANDARD SIZE RUBBER	STANDARD SIZE POLY	OVERSIZE RUBBER	OVERSIZE POLY
R3014985		223157	800 Series	1	15-7/8"	R304677A/G-4677A	R307427	R304678A/G-4678A	-
R304791		223214	300, 600 & 700 Series	0 & 1	21-1/2"	R304677A/G-4677A	R307427	R304678A/G-4678A	-
R3014978		805214	700 & 800 Series	2	21-1/2"	R307766/G-7766	R307426	R307767/G-7767	R308917
R3014990		805216	800 Series	2	21-3/4"	R307766/G-7766	R307426	R307767/G-7767	R308917
R3014991		805220	800 Series	2	22"	R307766/G-7766	R307426	R307767/G-7767	R308917
R304792		223240	300 & 700 Series	0 & 1	24"	R304677A/G-4677A	R307427	R304678A/G-4678A	-
R3014979		805240	700 Series	2	24"	R307766/G-7766	R307426	R307767/G-7767	R308917
R3014977		223330	700 Series	1	33"	R304677A/G-4677A	R307427	R304678A/G-4678A	-

Chalmers



Bushings Not Included

MERITOR NO.	GENUINE	OEM REF	JOINT TYPE	LENGTH	BUSHINGS				NOTES
					STANDARD SIZE RUBBER	STANDARD SIZE POLY	OVERSIZE RUBBER	OVERSIZE POLY	
R3014986		800049	2	24 1/4"	R307766/G-7766	R307426	R307767/G-7767	R308917	46-50K

TORQUE ARMS

TORQUE ARMS

Rigid - Listed Alphabetically by OEM

Suspension

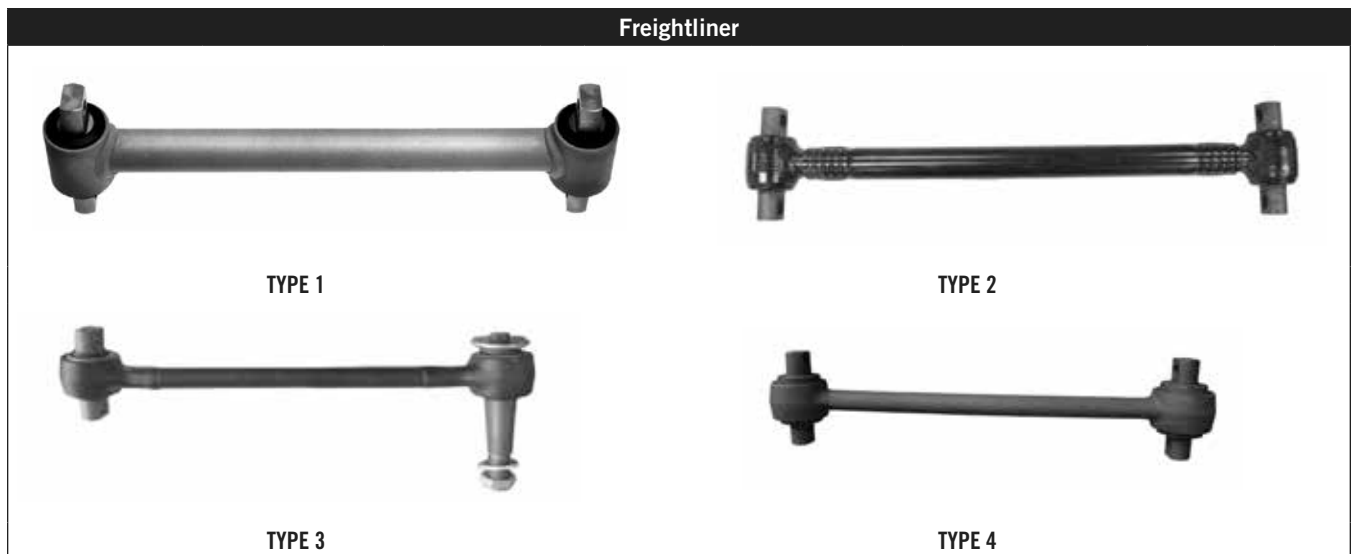

Includes Bushings

MERITOR NO.	MACH NO.	OEM REF	FOR MODELS	BUSHING NO.	LENGTH	BUSHING ANGLE	TUBE DIA	TYPE
R309869	-	16-13054-000	FH36-40	Not Rebushable	16-5/8"	2° / 12°	1 15/16"	1
R308941	G-8941	16-13053-000	FH34A / 36-40	Not Rebushable	16-5/8"	2° / 12°	1 9/16"	1
R303546	G-3546	16-10420-001	FH34 - 44	Not Rebushable	18-3/16"	3° / 10°	1 9/16"	1
R308808	-	681-326-63-16	FAS II	R305275	22 15/16"	0°, 35°	-	1
R3015536	G-15536	681-326-67-16		R305275	23 15/16"	0°, 35°	-	1
R3016277	-	16-16749-001		R305275	23 15/16"	0°, 35°	-	4
R3015542	-	16-16749-002		R305275	24 3/8"	0°, 35°	-	1
R3016653	G-16653	16-14149-002		R302228, R3010303	24 7/16" 7.5° Twist	0°, 35°	-	3
R3016058	-	16-15002-000		TufTrac	Includes R3016064 Bushings.	23 1/4"	Front Bushing +10°; Rear Bushing +7°	-
R3016059	-	16-15002-001	Includes R3016064 Bushings.		23 1/4"	Front Bushing +6 1/2°; Rear Bushing +4°	-	2
R3016054	-	16-14998-001	Includes R3016063 Bushings.		24 7/16"	Front Bushing +4°; Rear Bushing +7°	-	2
R3016055	-	16-14998-000	Includes R3016063 Bushings.		24 1/2"	Front & Rear Bushing 0°	-	2
R3016222	-	16-15004-000	Includes R3016063 Bushings.		26 3/8"	Front Bushing -6°; Rear Bushing -7°	-	2
R3016223	-	16-15004-001	Includes R3016063 Bushings.		26 3/8"	Front Bushing -6°; Rear Bushing +4°	-	2

TORQUE ARMS

Bushing Angles

Top of Torque Arm
Front of Vehicle

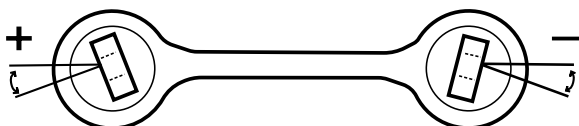

Many Truck/Tractor drive axle torque arms have straddle mount/bar pin style bushings that are NOT perpendicular to the center shaft. When the bushings are rotated, most are rotated counter clockwise as shown on the left which is considered "positive". "Negative" rotation is clockwise as shown on the right end of the drawing.

TORQUE ARMS

Rigid - Listed Alphabetically by OEM

Fruehauf



Bushings Not Included

MERITOR NO.	MACH NO.	OEM REF	FOR MODELS	BUSHING NO.	USES BUSHING KIT	LENGTH
R302514	G-2514	UXA-000026-001	All	R30927 / G-927	R301023	15 7/16"

Hendrickson



TYPE 1

TYPE 2

MERITOR NO.	GENUINE	OEM REF	FOR MODELS	BUSHING NO.	BUSHING ANGLE	LENGTH	NOTES	TYPE
R309409		48411-006	All HAS Models Except HAS 230/460, HFS	R305275	10° / 10°	14-13/32"	Includes Bushings	1
R309394		62007-365	HAS 230/460 Models	R305275	0° / 0°	14-13/32"	Includes Bushing	2
R303773		S-1031	HLQ, Q Series	R301980 R301981 KIT	-	15-1/2"	Without Bushings	2
R3016364		77906-398	HTB For International	-	0° / 8°	15 11/16"	Includes Bushings, Bushings Not Replacable	1
R303731		48411-001	HA Models	R305275	-	15-27/32"	Includes Bushings	1
R305282		48158-001; FORD E4HZ4612A	E4 Series	R305275/ R305276	-	15-7/8"	Includes Bushings (1) Bar Pin, (1) Hollow Bushing	2
R303774A-2		S-1031-1	HLQ, Q Series	R301980 R301981 KIT	-	19"	Without Bushings	2
R309407		48411-007	HFS	R305275	-	20-5/16"	Includes Bushings	1
R303732		48411-002	HA Models	R305275	-	21-15/16"	Includes Bushings	1
R305283		48158-002; FORD E4HZ4612B	E4 Series	R305275/ R305276	-	21-15/16"	Includes Bushings (1) Bar Pin, (1) Hollow Bushing	2
R3013993		58757-006	PRIMAXX & PRIMAXX EX	R3013961	0° / 0°	22"	Includes Bushings	2

TORQUE ARMS

TORQUE ARMS

Rigid - Listed Alphabetically by OEM

Suspension

Hutchens								
								
TYPE 1			TYPE 2					
MERITOR NO.	GENUINE	MACH NO.	OEM REF	FOR MODELS	INCLUDES BUSHING NO.	USES BUSHING KIT	LENGTH	TYPE
R3016395		-	715-00	H7700, H9700	R30934	R303079	19 1/4"	1
R302899	-	G-2899	715-00	H7700, H9700	R30934	R303079	19 1/4"	1
R309477		-	11953-01	H-7600, CH-7600 H-9600, CH-9600	Not Included. Use R30927	R309478	19 1/4"	2

Kenworth						
						
TYPE 1			TYPE 2			
Includes Bushings						
MERITOR NO.	OEM REF	FOR MODELS	BUSHING NO.	LENGTH	TYPE	
R3015708	K195-375; 925031	Airglide 100	R302226	24"	1	
R3015711	K195-376; 944270	Airglide 100	R3010303; R302228	24"	2	
R3015611	9259150	Airglide 100	R302226	25"	1	

TORQUE ARMS

TORQUE ARMS

Rigid - Listed Alphabetically by OEM

Mack



TYPE 1



TYPE 2

Includes Bushings

MERITOR NO.	OEM REF	FOR MODELS	BUSHING NO.	LENGTH	TYPE
R3013993	58757-006	MaxAir Twisted Sister	R305275	22"	1
R308821	35801-0068	Mack / Volvo Corporate Air Ride	R309395	22-1/8"	2

Meritor



Includes Poly Bushings

MERITOR NO.	GENUINE	FOR MODELS	BUSHING NO.	LENGTH
A-3133-G-8249		RHP/MPA	R3017029	21 1/2"

Navistar



TYPE 1



TYPE 2

Includes Bushings

MERITOR NO.	OEM REF	FOR MODELS	BUSHING NO.	LENGTH	BUSHING ANGLE	TYPE
R303788	493920C1, 588117C91, 923905	4-Spring (Front) & Air Ride "Z" Spring	R302226	18-1/8"	15° / 15°	1
R3010764	588117C91, 588117C92, 4939920C2	4-Spring (Front) & Air Ride "Z" Spring	R305275	18-1/8"	15° / 15°	2
R303789	493921C1, 493921C2, 923915	4-Spring (Rear)	R302226	21-31/32"	15° / 15°	1
R3010765	588118C91, 588118C92	4-Spring (Rear)	R305275	21-31/32"	15° / 15°	2
R3016075	3580088C1, 3548381C1	New Corporate Air Ride "Hockey Stick" Spring	Not Rebushable	25-3/8"	0° / 0°	2

TORQUE ARMS

TORQUE ARMS

Rigid - Listed Alphabetically by OEM

Suspension

Neway / SAF-Holland



Includes Bushings

MERITOR NO.	GENUINE	OEM REF	BUSHING NO.	LENGTH
R304319		915 44 001	R302939	14-9/16"

Peterbilt



TYPE 1



TYPE 2



TYPE 3

MERITOR NO.	MACH NO.	OEM REF	FOR MODELS	BUSHING NO.	LENGTH	TYPE
R305082	G-5082	03-04119	Air Trac	R302226	17-11/32"	1
R305083	G-5083	03-0419	Air Trac	R302226 & R303868	17-11/32"	1
R307887	G-7887	03-05849	Quadflex	Not Rebusable	18-7/16"	2
R304753	G-4753	03-01781, 03-04839	Four Spring	R305275	19-1/8"	3
R304771	G-4771	03-04059	Air Trac, Air Leaf	R302225	23"	1
R3016098	G-16098	C65-6000-001	Flex Air	Not Rebusable	23-3/4"	2
R3015709	-	C65-6002, C65-6009	Flex Air	R305275 New Arms Not Rebusable, Older Requires May Use R305275	25-1/2"	1
R3016118	G-16118	TR030020010	Airglide 210	Not Rebusable	25-9/16"	3
R307853	G-7853	03-05108	Low Air Leaf	R302225	25-5/8"	3
R3016099	G-16099	C65-6000-002	Flex Air	Not Rebusable	34-5/8"	2

TORQUE ARMS

TORQUE ARMS

Rigid - Listed Alphabetically by OEM

Reyco



TYPE 1



TYPE 2



TYPE 3



TYPE 4

MERITOR NO.	GENUINE	MACH NO.	OEM REF	FOR MODELS	INCLUDES BUSHING, HANGER END	INCLUDES BUSHING, AXLE SEAT END	BUSHING ASSEMBLY, HANGER SEAT END	BUSHING ASSEMBLY, AXLE SEAT END	LENGTH	TYPE
R309585	R	-	16585-01	74B 50"-60", 74B 72"-109", 74 AR	R309549	R309549	R309587	R309587	14-1/4"	4
R307744	R	-	10040-01	73, 73 WS, 83	R307750	R301980	R307749	R301981	15"	3
R302855	R	-	15178-01	21B Cast, 21B FAB, 21AR	Not Included, Use R301160	Not Included, Use R301160	R301312A	R301312A	16-1/4"	1
R3016540	R	-	20121-01	240AR	R3010057	R301980	R309350	R301981	16-3/4"	4
R302856	R	-	15179-01	21B Cast	Not Included, Use R301160	Not Included, Use R301160	R301312A	R301312A	18-5/8"	1
R304825	R	G-4825	0075-20	86AR, 86-88	R301980	R301980	R304834A	R304834A	19-5/8"	4
R302860	R	-	12051-01	101A, 102W, 102AR	R301964 (101A) R3010057 (102W/102AR)	R301980	R301963 (101A) R309350 (102W/102AR)	R301981	20-1/2"	2
R302858	R	-	15012-01	102	Not Included, Use R3010057	Not Included, Use R301982	R309350	R301983	21"	1
R309619	R	-	16588-01	74B 50"-60"	R309549	R301982	R309587	R301983	21-1/4"	4
R3015293	R	-	16589-01	74B 50"-60"	R309549	R301982	R309587	R301983	24-1/2"	4
R305256	R	-	09686-01	21B FAB	Not Included, Use R301160	Not Included, Use R301160	R301312A	R301312A	25"	1
R307746	R	-	12422-01	73 WS	R307750	R301980	R307749	R301981	25-1/4"	4
R3015266	R	-	20012-01	21AR, 74AR, 86AR	R301980	R301980	R301981	R301981	38"	3
R3015276	R	-	10910-01	21AR, 74AR, 86AR	R301980	R301980	R301981	R301981	44"	3

TORQUE ARMS

TORQUE ARMS

Rigid - Listed Alphabetically by OEM

Suspension

Trailmobile					
					
Includes Bushings					
MERITOR NO.	OEM REF	FOR MODELS	BUSHING NO.	USES BUSHING KIT	LENGTH
R303391	3-A11-64	Fabricated Equalizer 3-1/2" Wide Springs	R30934	R303079	17"

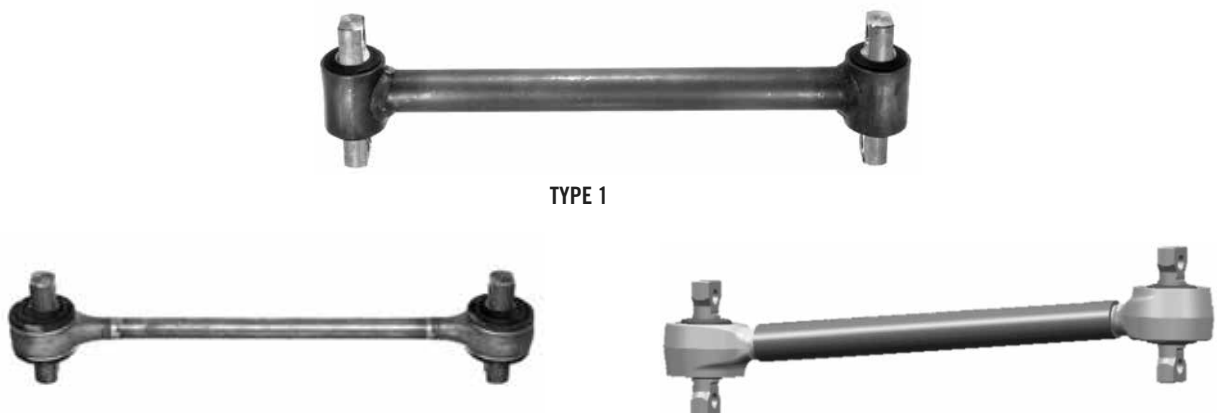
Volvo					
					
TYPE 1					
TYPE 2					
TYPE 3					
Includes Bushings					
MERITOR NO.	OEM REF	FOR MODELS	BUSHING NO.	LENGTH	TYPE
R308821	35801-0068	Volvo Corporate Air Ride	R309395	22-1/8"	1
R308853	8028945	Volvo T Ride Up To 2005	Not Rebushable	22-5/8"	2
R3016818	20443046	Volvo T Ride 2006 And Later	S.O.S.	22-5/8"	3

TORQUE ARMS

UNI-ROD® KITS

Individual Components

Uni-Rod Kits Require Two Ends
And A Connector Tube

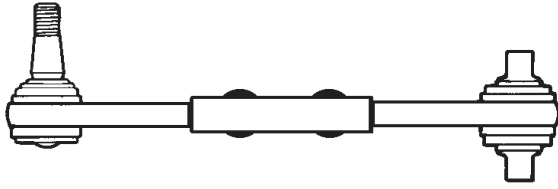

Uni-Rod Straddle Arm

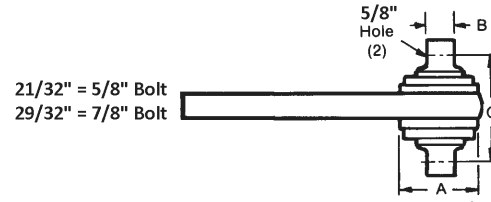

MERITOR NO.	OEM REF	HOLE DIA.	A	B	C
R303170	O&S SU 236	21/32"	3 3/8"	1 1/8"	4 3/8"
R303171	O&S SU 348	21/32"	3 3/4"	1 1/8"	4 3/8"
R303987	O&S SU 372	29/32"	3 3/4"	1 1/8"	4 3/8"

Uni-Rod Ball Stud

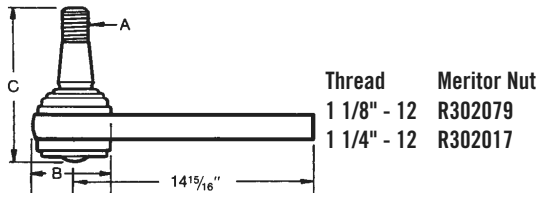

Nut Not Furnished

MERITOR NO.	OEM REF	A THREAD	B	C
R303165	O&S BU 235	1 1/8"-12	3 3/8"	6 9/64"
R303166	O&S MU 239	1 1/4"-12	3 3/8"	6 11/64"
R303167	O&S BU 347	1 1/4"-12	3 3/4"	7 43/64"
R303168	O&S MU 318	1 1/4"-12	3 3/4"	6 39/64"

Uni-Rod Offset Straddle Ball

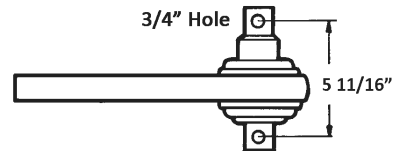

MERITOR NO.	OEM REF
R303185	O&S SU 359

Uni-Rod Hollow Ball

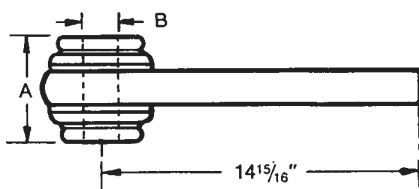

MERITOR NO.	OEM REF	A	B
R303169	O&S HU 351	3 1/4"	1 1/8"

Uni-Daptor (Connector Tube)



MERITOR NO.	OEM REF	A
R303172	O&S 8151-1	8"
R303173	O&S 8607-1	18"

NOTE: Nuts and Washers Furnished with Kits Only.

TORQUE ARMS

Popular Kits

STRADDLE BALL — STRADDLE BALL
34,000 - 36,000 lb. Suspensions

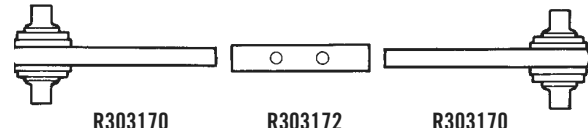

MERITOR NO.	OEM REF
R303176	O&S SU 3436

BALL STUD — STRADDLE BALL
For Mack 38,000 lb. Suspension

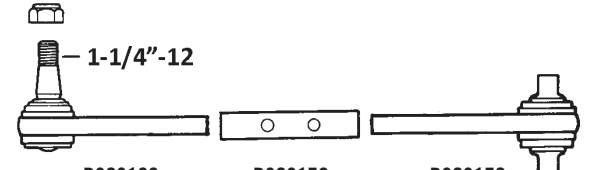

Nut Furnished

MERITOR NO.	OEM REF
R303177A	O&S SMU 3800

STRADDLE BALL — STRADDLE BALL
For 38,000 - 55,000 lb. Suspensions

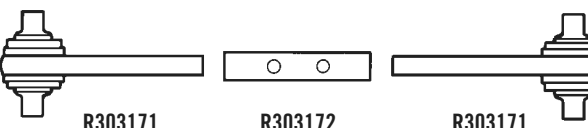

MERITOR NO.	OEM REF	NOTES
R303180	O&S SU 3844	Brockway requires drilling the 21/32" Dia. Holes oversize to 25/32".

BALL STUD — STRADDLE BALL
38,000 - 55,000 lb. Suspensions

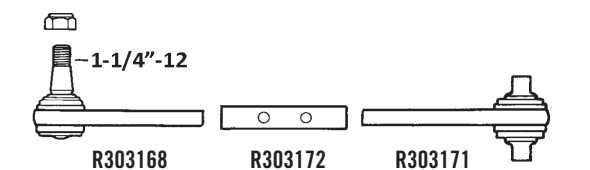

Includes Nut

MERITOR NO.	OEM REF
R303179A	O&S SMU 4044

BALL STUD — STRADDLE BALL
34,000 - 36,000 lb. Suspensions

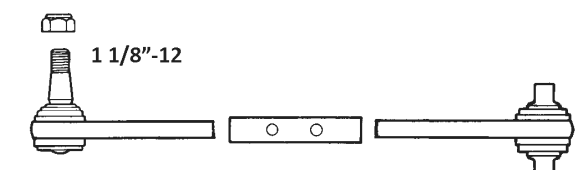

Includes Nut

MERITOR NO.	OEM REF
R303174	O&S SBU 3436

BALL STUD — STRADDLE BALL
For Mack 38,000 - 65,000 lb. Suspension

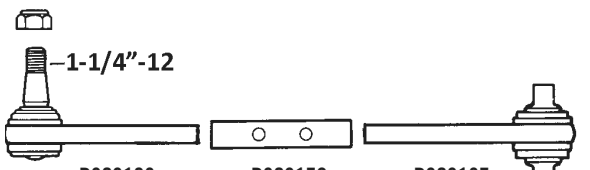

Nut Furnished

MERITOR NO.	OEM REF
R303988	O&S LMU 4044

BALL STUD — STRADDLE BALL
38,000 - 55,000 lb. Suspensions. Nut Furnished

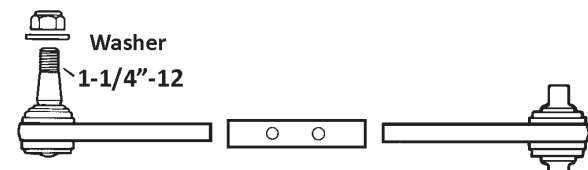

MERITOR NO.	OEM REF	NOTES
R303178	O&S SBU 3844	Brockway requires drilling the (2) 21/32" Dia. Holes oversize to 25/32" Dia.

BALL STUD — BALL STUD
34,000 - 36,000 lb. Suspensions

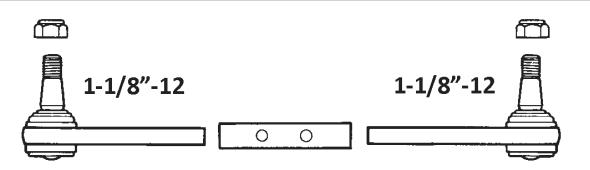

Includes Nut

MERITOR NO.	OEM REF
R303175	O&S SBU 3436

NOTE: Nuts and Washers Furnished with Kits Only.

Popular Kits

BALL STUD — BALL STUD (Opposite)
34,000 - 36,000 lb. Suspensions

Includes Nut

MERITOR NO.	OEM REF
R303175	O&S SU 3436

HOLLOW BALL — STRADDLE BALL
For 38,000 - 55,000 lb. Suspension

MERITOR NO.	OEM REF
R303182	O&S SHU 3844

BALL STUD — BALL STUD
For 38,000 - 55,000 lb. Suspension

Nut Furnished

MERITOR NO.	OEM REF
R303181	O&S BU 3844

HOLLOW BALL — HOLLOW BALL
For 38,000 - 55,000 lb. Suspension

MERITOR NO.	OEM REF
R303184	O&S HU 3844

BALL STUD — BALL STUD (Opposite)
For 38,000 - 55,000 lb. Suspension

Nut Furnished

MERITOR NO.	OEM REF
R303181	O&S BU 3844

OFFSET STRADDLE BALL — HOLLOW BALL
For Navistar 38,000 - 44,000 lb. Suspensions

MERITOR NO.	OEM REF
R303186	O&S IHU 3444

BALL STUD — BALL STUD
For Mack 40,000 - 44,000 lb. Suspension

Nut Furnished

MERITOR NO.	OEM REF
R303183A	O&S MU-4044

NOTE: Nuts and Washers Furnished with Kits Only.

TORQUE ARMS

UNI-ROD UNIVERSAL BALL JOINT TORQUE ARMS ASSEMBLY INSTRUCTIONS

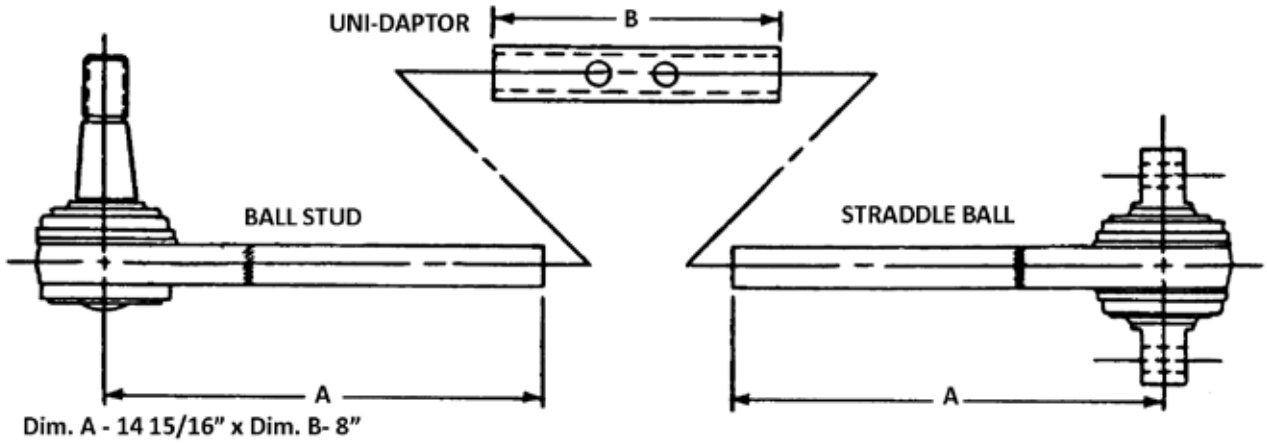

To Fabricate Uni-Rod to required length:

- (1) Determine finished length
- (2) Reading from tape supplied with Uni-Rod, cut each Uni-Rod end to proper length
- (3) Slip Uni-Rod ends into Uni-daptor so that the rods butt in the center
- (4) Puddle weld and fillet weld according to instructions

NOTE: The measuring tapes supplied have been calibrated to provide the proper finished length.

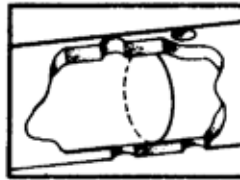
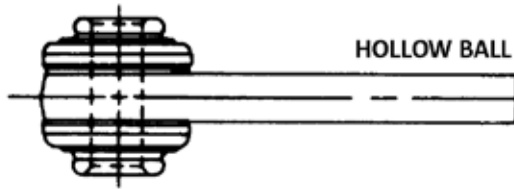

Phantom View - Rods Should Butt Inside Center Of Uni-daptor

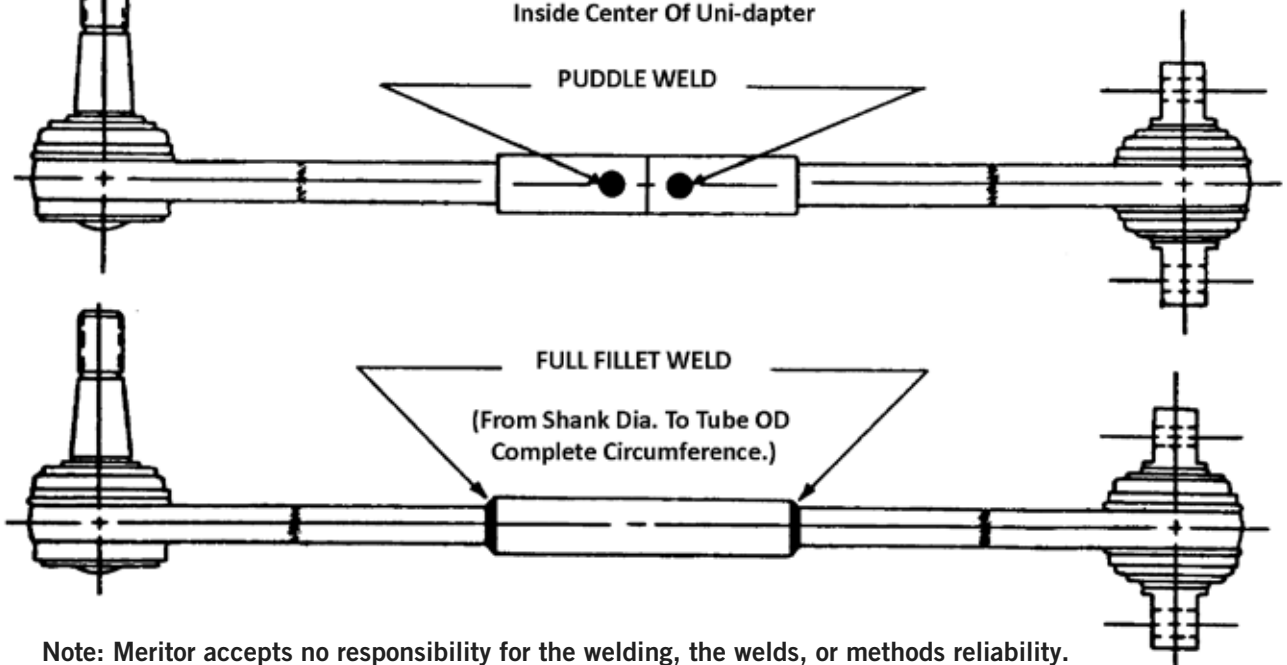

Note: Meritor accepts no responsibility for the welding, the welds, or methods reliability.

TORQUE ARMS



HENDRICKSON ULTRA ROD® KITS

Hendrickson Kits Require A Tube end and Spacer End. Tube & Spacer End Include Bushing

Ultra Rod - Tube End					
	MERITOR NO.	HENDRICKSON NO	REPLACEMENT BUSHING	MOUNTING CENTER (A)	HOLE DIAMETER (INCHES)
Straddle Mount Tube End					
	R3010310	66610-000	R305275	4 3/8"	5/8"
	R3011784	66766-000	R3016466	4 3/8"	7/8"
	R3011748	66767-000	R3010322	4 3/8"	3/4"
Offset Straddle Mount -Tube End					
	R3010313	66640-000	R3010320	5 11/16"	3/4"
Hollow Sleeve Tube End					
	R3010314	66650-000	R3011447	-	1 1/8"
	MERITOR NO.	HENDRICKSON NO	REPLACEMENT BUSHING	TAPER PIN (A)	THREAD (B)
Tapered Stud Tube End					
	R3010311	66620-000	R3010308	1 7/8"	1 1/8"
	S.O.S.	66769-000	R3010321	1 3/4"	1 1/4"
	R3010312	66630-000	R3010309	2 3/4"	1 1/4"
INCLUDES NUT					

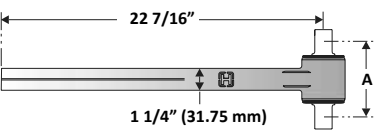
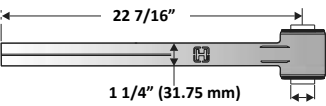
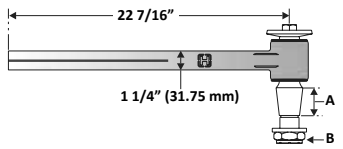
TORQUE ARMS

Ultra Rod - Spacer End											
	MERITOR NO.	OEM REF	REPLACEMENT BUSHING	MOUNTING CENTER (A)	HOLE DIAMETER (INCHES)						
Straddle Mount Rod											
	R3010315	6661-000	R305275	4 3/8"	5/8"						
	R3014727	67047-000	R3010322	4 3/8"	3/4"						
	S.O.S.	67048-000	R3016466	4 3/8"	7/8"						
	S.O.S.	66768-000	R3010320	5 11/16"	3/4"						
Hollow Sleeve Rod											
	R3010319	66701-000	R3011447	-	1 1/8"						
<table border="1"> <thead> <tr> <th></th> <th>MERITOR NO.</th> <th>HENDRICKSON NO.</th> <th>REPLACEMENT BUSHING</th> <th>TAPER PIN (A)</th> <th>THREAD (B)</th> </tr> </thead> </table>							MERITOR NO.	HENDRICKSON NO.	REPLACEMENT BUSHING	TAPER PIN (A)	THREAD (B)
	MERITOR NO.	HENDRICKSON NO.	REPLACEMENT BUSHING	TAPER PIN (A)	THREAD (B)						
Tapered Stud Rod											
	R3010318	66691-000	R3010321	1 3/4"	1 1/4"						
	R3010316	66671-000	R3010308	1 7/8"	1 1/8"						
	R3010317	66681-000	R3010309	2 3/4"	1 1/4"						
Includes Nuts											

Lock Nuts and Washers for Tapered Stud Torque Rods						
	MERITOR NO.	OEM REF	THREAD	HEX	HIGH	SERIES
	R302079	Hendrickson 29896	1 1/8" -12	1 5/8"	1 3/16	340
	R302017	Hendrickson 29749	1 1/4" -12	1 13/16"	11/16"	400, 460
	MERITOR NO.	OEM REF	OD	ID	THICK	SERIES
	R302018	Hendrickson 30574	2 1/4"	1 5/16"	1/4"	400, 460

NOTE: Length measured from center-to-center of bushing.

Assembly options shown on following page.

HENDRICKSON ULTRA ROD® KITS

Ultra Rod® - Option Configurations

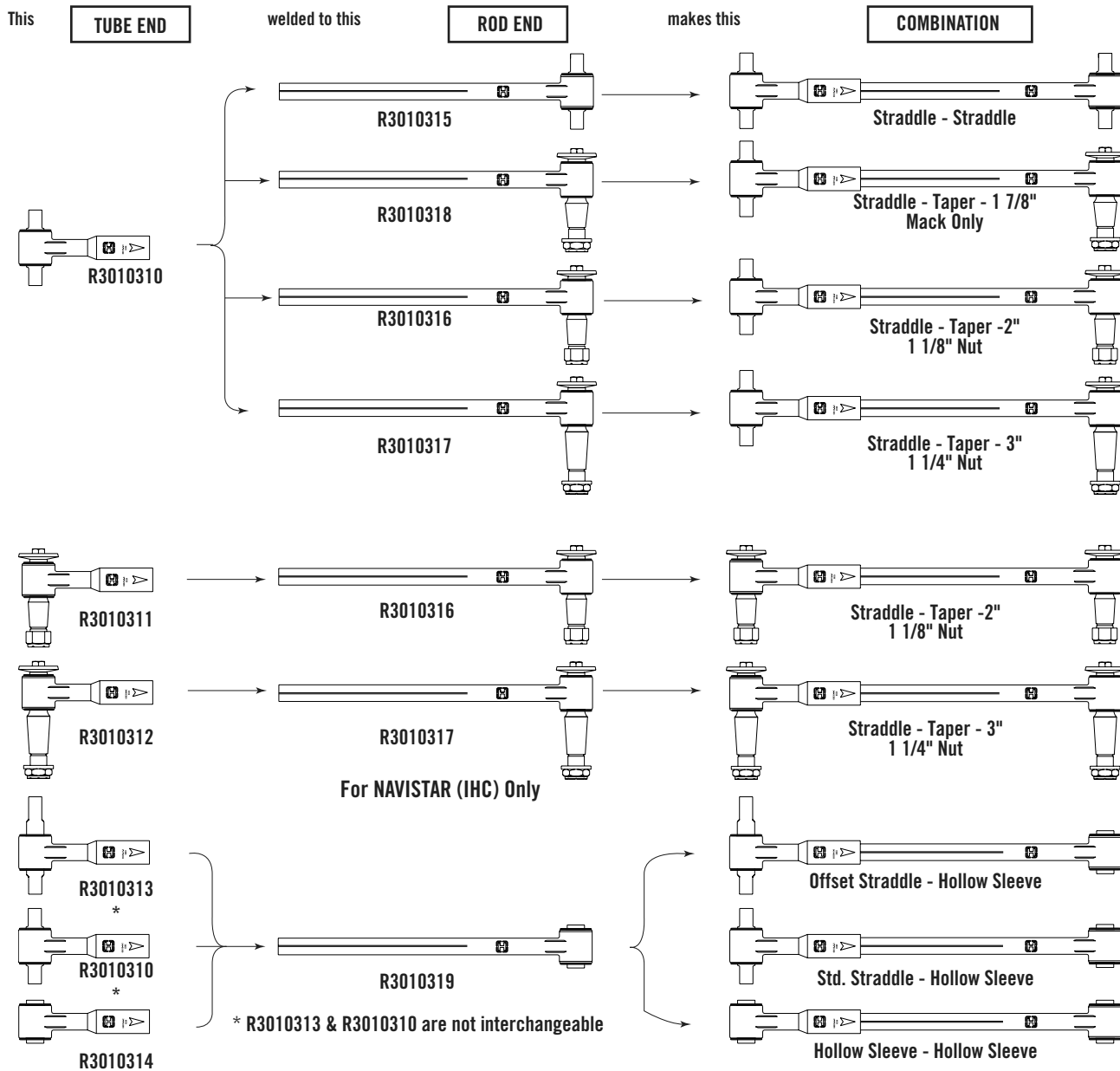

TORQUE ARMS

Ultra Rod® Plus™ Kits - Require a tube end & space end as well as the proper bushings.
 Bushing can be found in the Hendrickson Section.
 Refer to Hendrickson Publication 59310-002 for welding instructions.

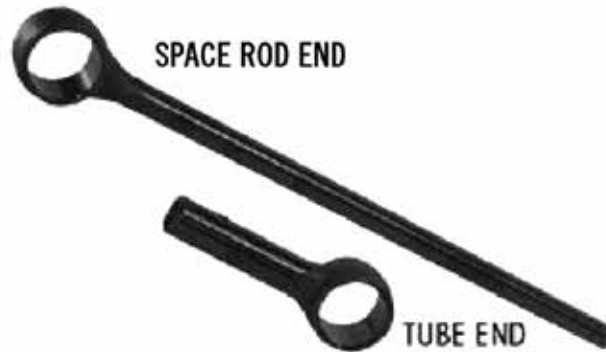

An excellent replacement option for vocational and on-highway applications.
 Tube and spacer are made from One-Piece forgings.

Empty Ends Hubs - offer added versatility to ULTRA ROD PLUS torque rods. Empty end hubs allow the use of any PLUS bushing configuration from existing Hendrickson torque rods. The two-piece design requires stocking only two part numbers, eliminating multiple torque rod inventory. Refer to Torque Rod Bushings Section for specific torque rod bushing information

Female Tube End			
MERITOR NO.	GENUINE	OEM REF	DESCRIPTION
R3011820		64473-000	Tube End

Male Spacer Rod End			
MERITOR NO.	GENUINE	OEM REF	DESCRIPTION
R3011821		64474-000	Spacer End

Ultra Plus Rod Bushing Installation Tool			
MERITOR NO.	GENUINE	OEM REF	APPLICATION
R3013974		66086-000	For Ultra Rod Plus Bushings

TORQUE ARMS

SUSPENSION BUSHINGS

Listed by Type, Then by ID

E.S.P. GUIDE**Easy Search for Parts****HOW TO USE THIS GUIDE:**

1. Identify bushing type. Bushings are listed by type beginning with Type 1.
2. Measure bushing ID. For Type 5 bushings, the thread size is shown in the ID column. For Type 7, the pin diameter is shown in ID column.
3. Bushings in this guide are listed in order from smallest to largest ID, then OD, then Length.
4. If there is not a typical measurement for ID, such as Type 3 bushings, then the ID space is blank.
5. After matching up bushing dimensions, confirm your choice by bushing type, end component, material and application.







TYPE 1 One-Piece		TYPE 2 Straight Two-Piece		TYPE 3 Straddle Mount		TYPE 4 Tapered Two-Piece		TYPE 5 Tapered Stud		TYPE 6 Hendrickson Center Bushing		TYPE 7 Rubber Spring Eye Bushing	
													
One bushing is required to service one component or one component end.		Two bushings are required to service one component or component end.		Length on guide is center-to-center.		Two bushings are required to service one component or component end. OD is larger dia.		Length on guide is stud shoulder length; ID is thread size.		Small OD is measured first.		ID on the guide is Pin Diameter	
MERITOR NO.	MACH NO.	ID	OD	LENGTH	TYPE	END COMPONENT	MATERIAL	APPLICATION / NOTES					
R3016236	G-16236	5/8"	1 3/4"	4 1/4"	1	Spring Eye	Rubber/Steel	Kenworth Front					
R3013961	-	5/8"	3 1/4"	4 3/8"	1	Torque Rod	Rubber/Steel	Hendrickson Ultra Rod PLUS					
R303839	-	3/4"	1 3/8"	3"	1	Rebound	Rubber	Volvo					
R3014632	-	3/4"	2 3/16"	3 1/4"	1	Spring Eye	Rubber/Steel	Hendrickson Airtek					
R303359	-	3/4"	2 3/8"	3"	1	Equalizer	Rubber/Steel	Reyco Shackle Bushing					
R301999A	G-1999A	3/4" (2)	3 1/4"	3 7/8"	1	Equalizer	Rubber/Steel	Hutchens, Great Dane					
R307452	-	3/4" (2)	3 1/4"	3 7/8"	1	Equalizer	Polyurethane/Steel	Hutchens					
R303394A	-	3/4" (2)	3 1/4"	4 7/16"	1	Equalizer	Polyurethane/Steel	Trailmobile					
R3013964	-	3/4"	3 1/4"	5 11/16"	1	Torque Rod	Rubber/Steel	Hendrickson Ultra Rod PLUS					
R303849	-	7/8"	1 3/4"	3 1/4"	1	Spring Eye	Rubber/Steel	Volvo/White					
R303817	G-3817	7/8"	1 3/4"	4"	1	Spring Eye Bracket	Rubber/Steel	Freightliner					
R301980	G-1980	7/8"	1 29/32"	3"	1	Torque Arm	Rubber/Steel	Reyco, Navistar/Dayton					
R307520	-	7/8"	1 29/32"	3"	1	Torque Arm	Polyurethane/Steel	Reyco, Navistar/Dayton					
R301061	-	7/8"	1 29/32"	3"	1	Hanger	Rubber/Steel	Reyco Rebound Roller					
R307750	-	7/8"	1 29/32"	3 3/8"	1	Torque Arm	Rubber/Steel	Reyco					
R305276	-	7/8"	2"	3"	1	Torque Arm	Rubber/Steel	Hendrickson					
R303362	-	7/8"	2 1/32"	3"	1	Torque Arm	Rubber/Steel	Ford/Reyco 181/101F					
R303086	-	7/8"	2 3/8"	3"	1	Torque Arm	Rubber/Steel	Navistar/Dayton Tractor					
R305270	-	7/8"	2 3/8"	3"	1	Equalizer	Rubber/Steel	Hendrickson R30360					
R3016097	-	7/8"	2 3/8"	3"	1	Spring Eye	Rubber/Steel	Peterbilt					
R3016777	-	7/8"	2 9/16"	3 9/16"	1	Spring Eye	Rubber/Steel	Mack, Volvo					
R309286	-	15/16"	3 1/2"	4 1/4"	1	Beam	Rubber/Steel	Neway ARDAB					
R30934	G-934	1"	1 29/32"	3"	1	Torque Arm	Rubber/Steel	Hutchens, Trailmobile					
R3016504	-	1"	1 29/32"	3"	1	Torque Arm	Rubber/Steel	Hutchens, Trailmobile, Genuine Hutchens					
R307453	-	1"	1 29/32"	3"	1	Torque Arm	Polyurethane/Steel	Hutchens					
R309549	-	1"	2 3/8"	4"	1	Torque Arm	Rubber/Steel	Reyco 74B					
R3016775	-	1"	2 1/2"	4 1/2"	1	Spring Eye	Rubber/Steel	Mack					

(2) = Bushing with 2 - 5/8" holes.

SUSPENSION BUSHINGS

Suspension

Listed by Type, Then by ID

TYPE 1 One-Piece	TYPE 2 Straight Two-Piece	TYPE 3 Straddle Mount	TYPE 4 Tapered Two-Piece	TYPE 5 Tapered Stud	TYPE 6 Hendrickson Center Bushing	TYPE 7 Rubber Bushing
						
One bushing is required to service one component or one component end.	Two bushings are required to service one component or component end.	Length on guide is center-to-center.	Two bushings are required to service one component or component end. OD is larger dia.	Length on guide is stud shoulder length; ID is thread size.	Small OD is measured first.	ID on the guide is Pin Diameter

MERITOR NO.	MACH NO.	ID	OD	LENGTH	TYPE	END COMPONENT	MATERIAL	APPLICATION / NOTES
R305269	-	1"	2 3/4"	4 5/8"	1	Equalizer	Rubber/Steel	Hendrickson E4-360, E4-400
R302273	-	1"	3 1/8"	5"	1	Equalizer	Rubber/Steel	Dana
R307870	-	1 1/64"	3 3/4"	5 1/4"	1	Equalizer	Rubber/Steel	Peterbilt Quadreflex
R303784	G-3784	1 1/32"	2 1/2"	4 23/32"	1	Equalizer	Rubber/Steel	Navistar Corporate
R304827	G-4827	1 1/32"	3 5/16"	4"	1	Equalizer	Rubber/Steel	Binkley, Reyco/Transpro 86, 88
-	G-16141	1 1/8"	1 3/8"	3"	1	Spring Eye	Bi-Metal	Oshkosh Front
-	G-15538	1 1/8"-6	1 3/4"	4"	1	Spring Eye Threaded	Steel	Kenworth Front
R309506	-	1 1/8"	2 1/8"	2 13/16"	1	Cab Tilt	Polyurethane/Steel	Volvo
R304255	G-4255	1 1/8"	2 3/8"	5"	1	Beam	Rubber/Steel	Neway
R307485	-	1 1/8"	2 3/8"	5"	1	Beam	Polyurethane/steel	Neway
R304256	G-4256	1 1/8"	2 5/8"	5"	1	Beam	Rubber/Steel	Neway
R302816	-	1 1/8"	2 3/4"	3 1/4"	1	Torque Arm	Rubber/Steel	Hendrickson, Navistar
R304410A	G-4410A	1 1/8"	2 3/4"	5"	1	Beam	Rubber/Steel	Neway
R307444	-	1 1/8"	2 3/4"	5"	1	Beam	Polyurethane/steel	Neway
R301351	-	1 1/8"	2 7/8"	7"	1	Torque Arm	Rubber/Steel	Hendrickson, Navistar
R309457	-	1 1/8"	3"	2 15/16"	1	Beam	Rubber/Steel	Page
R302238	-	1 1/8"	3"	3 1/4"	1	Torque Arm	Rubber/Steel	Hendrickson, Navistar
R301352	-	1 1/8"	3 3/8"	3 1/4"	1	Torque Arm	Rubber/Steel	Hendrickson, Navistar
R307621	G-7621	1 1/8"	3 1/2"	3 7/8"	1	Equalizer	Rubber/Steel	Hutchens 9600, 9700
R3016501	-	1 1/8"	3 1/2"	3 7/8"	1	Equalizer	Rubber/Steel	Hutchens 9600, 9700 - Genuine
R308666	-	1 1/8"	3 1/2"	3 7/8"	1	Equalizer	Polyurethane/Steel	Hutchens 9600, 9700
R3016565	-	1 1/8"	3 1/2"	3 7/8"	1	Beam	Rubber/Steel	Neway
R309292	G-9292	1 1/8"	3 1/2"	5"	1	Beam	Rubber/Steel	Neway
R308683	-	1 1/8"	3 1/2"	5 1/4"	1	Beam	Polyurethane/Steel	Neway
R3013967	-	1 1/8"	3 1/4"	3 1/4"	1	Torque Rod	Rubber/Steel	Hendrickson, Ultra Rod Plus
R3016560	-	1 1/8"	3 1/2"	3 7/8"	1	Beam	Rubber/Steel	Neway
R3016561	-	1 1/8"	3 7/8"	3 7/8"	1	Beam	Rubber/Steel	Neway
R3016566	-	1 1/8"	4 3/4"	5"	1	Beam	Rubber/Steel	Neway
R303533	-	1 1/4"	1 1/2"	3 1/2"	1	Spring Eye	Bronze	Freightliner
R3016167	G-16167	1 1/4"	1 1/2"	3 1/2"	1	Spring Eye	Bi-Metal	Mack, Peterbilt Front
-	G-3534	1 1/4"-8	1 1/2"	3 1/2"	1	Spring Eye Threaded	Steel	Freightliner Front
R301876	-	1 1/4"	1 1/2"	4"	1	Spring Eye	Bi-Metal	Freightliner, Kenworth, Peterbilt Front
R3016153	-	1 1/4"	1 1/2"	4"	1	Spring Eye With Seals	Bi-Metal	Kenworth, Peterbilt Front
R308797	G-8797	1 1/4"	1 5/8"	4"	1	Spring Eye	Bronze	Freightliner
R302939	G-2939	1 1/4"	2 3/8"	2 1/2"	1	Torque Arm	Rubber/Steel	Neway
R308676	-	1 1/4"	2 3/8"	2 1/2"	1	Torque Arm	Polyurethane/Steel	Neway

SUSPENSION BUSHINGS







Listed by Type, Then by ID

TYPE 1 One-Piece	TYPE 2 Straight Two-Piece	TYPE 3 Straddle Mount	TYPE 4 Tapered Two-Piece	TYPE 5 Tapered Stud	TYPE 6 Hendrickson Center Bushing	TYPE 7 Rubber Bushing		
								
One bushing is required to service one component or one component end.	Two bushings are required to service one component or component end.	Length on guide is center-to-center.	Two bushings are required to service one component or component end. OD is larger dia.	Length on guide is stud shoulder length; ID is thread size.	Small OD is measured first.	ID on the guide is Pin Diameter		
MERITOR NO.	MACH NO.	ID	OD	LENGTH	TYPE	END COMPONENT	MATERIAL	APPLICATION / NOTES
R302940	-	1 1/4"	2 3/8"	5"	1	Beam	Rubber/Steel	Neway
R308677	-	1 1/4"	2 3/8"	5"	1	Beam	Polyurethane/Steel	Neway
R303900	-	1 1/4"	2 1/2"	4"	1	Spring Eye	Rubber/Steel	Mack
R302849	-	1 1/4"	3 1/8"	4 1/2"	1	Equalizer	Rubber/Steel	Ford/Reyco 101, Slotted
R302850	G-2850	1 1/4"	3 1/8"	4 1/2"	1	Equalizer	Rubber/Steel	GM/Ford/Reyco, No Slots
R307713	G-7713	1 1/4"	3 1/8"	4 5/8"	1	Equalizer	Rubber/Steel	Reyco
R306127	-	1 1/4"	3 3/8"	5 1/4"	1	Beam	Rubber/Steel	Hendrickson
R306126	-	1 1/4"	3 3/8"	10 1/2"	1	Beam	Rubber/Steel	Hendrickson
R3016567	-	1 1/4"	3 1/2"	5 1/4"	1	Beam	Rubber/Steel	Neway
R302938	-	1 1/4"	3 1/2"	5 13/16"	1	Beam	Rubber/Steel	Neway
R3013992	-	1 1/4"	3 3/4"	3 5/8"	1	Pivot	Rubber/Steel	Hendrickson Comfort Air
R308799	G-8799	1 1/4"-8	1 1/2"	4"	1	Spring Eye, Threaded	Steel	Freightliner
-	G-15667	M32-4.0	1 3/4"	4 1/8"	1	Spring Eye Threaded	Steel	Volvo Front
R30640	G-640	1 5/16"	2 5/16"	2 1/4"	1	Torque Arm	Rubber/Steel	Trailmobile
-	G-16157	M33.5-4.0	1 3/4"	4"	1	Spring Eye Threaded	Steel	Peterbilt Front
-	G-16158	M33.5-4.0	2 1/16"	4"	1	Spring Eye Threaded	Steel	Peterbilt Front
R304752	-	1 3/8"	2 5/32"	2 1/2"	1	Torque Arm	Rubber	Peterbilt Old Style
R301966	G-1966	1 1/2"	3 1/8"	4 1/2"	1	Equalizer	Rubber/Steel	Reyco, Slotted Ends
R303977	G-3977	1 1/2"	3 1/8"	4 1/2"	1	Equalizer	Rubber/Steel	Reyco, No Slots
R308654	-	1 1/2"	3 1/8"	4 1/2"	1	Equalizer	Polyurethane/Steel	Reyco, No Slots
R309439	-	1 1/2"	3 3/16"	4 7/16"	1	Beam	Rubber/Steel	Ridewell
R307515	-	1 5/8"	3 1/2"	4 1/2"	1	Miscellaneous	Polyurethane	Premier
R301336	-	1 3/4"	2 3/4"	2 3/8"	1	Shackle Pin	Rubber	Neway TL
R306121	-	1 3/4"	6"	6 3/4"	1	Beam	Rubber/Steel	Hendrickson Tri-Functional
R304669	G-4669	2"	2 7/8"	4"	1	Stabilizer	Rubber	Kenworth
R307446A	-	2"	2 7/8"	4"	1	Stabilizer	Polyurethane	Kenworth
R3016091	-	2"	3"	2 7/8"	1	Torsion Bar	Rubber, Improved OE Version	Kenworth
R303082	-	2"	3 1/8"	4 1/4"	1	Equalizer	Rubber	Navistar/Dayton, Volvo
R301072	-	2"	3 1/8"	4 1/4"	1	Equalizer	Rubber/Steel	Reyco, Spicer
R308688	-	2"	3 1/8"	4 1/4"	1	Equalizer	Polyurethane/Steel	Reyco, Spicer
R304254	G-4254	2"	3 3/8"	5 1/4"	1	Beam	Rubber/Steel	Neway
R307516	-	2"	3 1/2"	1 7/8"	1	Miscellaneous	Polyurethane	Premier
R307517	-	2"	3 1/2"	3 1/2"	1	Miscellaneous	Polyurethane	Premier
R309368	-	2"	3 1/2"	4"	1	Equalizer	Rubber/Steel	Fruehauf

SUSPENSION BUSHINGS

Suspension



Listed by Type, Then by ID

TYPE 1 One-Piece	TYPE 2 Straight Two-Piece	TYPE 3 Straddle Mount	TYPE 4 Tapered Two-Piece	TYPE 5 Tapered Stud	TYPE 6 Hendrickson Center Bushing	TYPE 7 Rubber Bushing
						
One bushing is required to service one component or one component end.	Two bushings are required to service one component or component end.	Length on guide is center-to-center.	Two bushings are required to service one component or component end. OD is larger dia.	Length on guide is stud shoulder length; ID is thread size.	Small OD is measured first.	ID on the guide is Pin Diameter

MERITOR NO.	MACH NO.	ID	OD	LENGTH	TYPE	END COMPONENT	MATERIAL	APPLICATION / NOTES
R301940	-	2"	4 1/8"	4"	1	Saddle Drive Pin	Rubber/Steel	Hendrickson
R309515	-	2"	4 1/8"	4"	1	Saddle Drive Pin	Polyurethane/Steel	Hendrickson
-	G-16107	2 1/8"	3"	2 7/8"	1	Torsion Bar	Rubber, Original Design	Kenworth
R3010302	-	2 1/8"	3"	2 7/8"	1	Torsion Bar	Polyurethane, Original Design	Kenworth
R3016092	-	2 3/16"	3"	2 7/8"	1	Torsion Bar	Rubber, Improved OE Version	Kenworth
-	G-16108	2 1/4"	3"	2 7/8"	1	Torsion Bar	Rubber, Original Design	Kenworth
R3016122	-	2 1/4"	3"	2 7/8"	1	Torsion Bar	Polyurethane, Original Design	Kenworth
R304677A	G-4677A	2 3/8"	3 5/8"	3 3/4"	1	Torque Arm	Rubber	Chalmers, Standard
R304678A	G-4678A	2 3/8"	3 11/16"	3 3/4"	1	Torque Arm	Rubber	Chalmers, Oversize - Genuine
R308702	-	2 3/8"	3 11/16"	3 3/4"	1	Torque Arm	Rubber	Chalmers, Oversize
R3016607	-	2 1/2"	3"	5 1/4"	1	Beam	Rubber/Steel	Neway
R3016564	-	2 1/2"	3"	6"	1	Beam	Rubber/Steel	Neway
R304252	G-4252	2 1/2"	3 7/8"	5 1/4"	1	Beam	Rubber/Steel	Neway ARD
R306128	-	2 1/2"	3 7/8"	5 1/4"	1	Beam	Rubber/Steel	Hendrickson MTL45
R304253	-	2 1/2"	3 7/8"	5 3/4"	1	Beam	Rubber/Steel	Neway ARD
R308681	-	2 1/2"	3 7/8"	5 3/4"	1	Beam	Polyurethane/Steel	Neway ARD
R301340	-	2 1/2"	4 3/8"	5 1/4"	1	Beam End	Rubber/Steel	Hendrickson 340
R302771	-	2 1/2"	4 3/8"	5 3/4"	1	Beam End	Rubber/Steel	Hendrickson 480
R301341A	-	2 1/2"	4 3/8"	5 3/4"	1	Beam End	Rubber/Steel	Hendrickson 400/460
R309512A	-	2 1/2"	4 3/8"	5 3/4"	1	Beam End	Polyurethane/Steel	Hendrickson 400/460
R309419	-	2 1/2"	4 3/8"	6"	1	Beam End	Rubber/Steel	Hendrickson 520/650
R307767	G-7767	2 1/2"	4 1/2"	4 1/8"	1	Torque Arm	Rubber	Chalmers
R307524	-	2 1/2"	4 3/4"	5 3/16"	1	Eye	Polyurethane	Silver Eagle
R307766	G-7766	2 9/16"	4 1/4"	4 1/8"	1	Torque Arm	Rubber	Chalmers
R309293	G-9293	2 5/8"	4 1/8"	5 1/4"	1	Beam	Rubber/Steel	Neway
R301545	-	2 3/4"	3 5/8"	5 7/8"	1	Beam Center	Bronze	Hendrickson
R301335	-	2 13/16"	3 3/4"	4"	1	Equalizer	Rubber	Neway TL
R302554	-	3"	6"	6"	1	Beam End	Rubber/Steel	Hendrickson 650
R302923A	-	3 7/16"	4 7/16"	7 9/16"	1	Trunnion	Rubber	Mack
R302924A	-	3 7/16"	4 7/16"	8 3/8"	1	Trunnion	Rubber	Mack
R307441	-	3 7/16"	4 7/16"	8 3/8"	1	Trunnion	Polyurethane	Mack
R302921A	-	3 7/16"	4 11/16"	5 9/16"	1	Trunnion	Rubber	Mack
R307478	-	3 7/16"	4 11/16"	5 9/16"	1	Trunnion	Polyurethane	Mack
R302922A	-	3 7/16"	4 11/16"	6 5/8"	1	Trunnion	Rubber	Mack
R307479	-	3 7/16"	4 11/16"	6 5/16"	1	Trunnion	Polyurethane	Mack

SUSPENSION BUSHINGS







Listed by Type, Then by ID

TYPE 1 One-Piece	TYPE 2 Straight Two-Piece	TYPE 3 Straddle Mount	TYPE 4 Tapered Two-Piece	TYPE 5 Tapered Stud	TYPE 6 Hendrickson Center Bushing	TYPE 7 Rubber Bushing		
								
One bushing is required to service one component or one component end.	Two bushings are required to service one component or component end.	Length on guide is center-to-center.	Two bushings are required to service one component or component end. OD is larger dia.	Length on guide is stud shoulder length; ID is thread size.	Small OD is measured first.	ID on the guide is Pin Diameter		
MERITOR NO.	MACH NO.	ID	OD	LENGTH	TYPE	END COMPONENT	MATERIAL	APPLICATION / NOTES
R302925	-	3 1/2"	3 3/4"	3 7/16"	1	Trunnion	Bronze	Mack
R304683	-	3 1/2"	4 1/16"	3 1/4"	1	Wishbone	Rubber/Steel	Chalmers
R307488	-	3 1/2"	4 1/2"	4"	1	Trunnion	Polyurethane	Page
R302935	-	3 1/2"	4 1/2"	5 3/4"	1	Trunnion	Rubber	Neway
R307443	-	3 1/2"	4 1/2"	5 3/4"	1	Trunnion	Polyurethane	Neway
R307489	-	3 1/2"	4 1/2"	8 3/4"	1	Trunnion	Polyurethane	Page
R307499	-	3 1/2"	4 1/2"	10 1/2"	1	Trailing Arm	Polyurethane	Peerless
R301552	-	3 1/2"	4 3/4"	5 7/8"	1	Beam Center	Bronze	Hendrickson
R309458	-	3 5/8"	5"	5 5/8"	1	Pivot Arm	Rubber	Page Lift Axles
R305421	-	4"	4 1/4"	4 5/16"	1	Trunnion	Bronze	Mack
R309521	-	4"	5"	4 5/8"	1	Trunnion	Rubber	Kenworth
R301333	-	4"	5"	5 3/4"	1	Trunnion	Rubber	Neway
R308672	-	4"	5"	5 3/4"	1	Trunnion	Polyurethane	Neway
R3025199	-	4"	5"	7 1/2"	1	Trunnion	Polyurethane	Hutchens H440 - Genuine
R303579	-	4"	5"	8 5/16"	1	Trunnion	Rubber	Fruehauf M2
R308663	-	4"	5"	8 5/16"	1	Trunnion	Polyurethane	Fruehauf M2
R301332	G-1332	4"	5"	8 3/4"	1	Trunnion	Rubber	Neway TS
R307486	-	4"	5"	8 3/4"	1	Trunnion	Polyurethane	Neway TS
R305216	G-5216	4"	5"	9"	1	Trunnion	Rubber	Hutchens H900
R307455	-	4"	5"	9"	1	Trunnion	Polyurethane	Hutchens H900
R3016502	-	4"	5"	9"	1	Trunnion	Rubber	Hutchens H900 - Genuine
R3016397	-	4"	5"	9"	1	Trunnion	Polyurethane	Hutchens H900 - Genuine
R307493	-	4 1/2"	5 1/2"	4 7/8"	1	Trunnion	Polyurethane	Page
R305432	-	5"	5 1/4"	4 5/16"	1	Trunnion	Bronze	Mack
R307474	-	5/8"	1 13/16"	1 1/4"	2	Shock	Polyurethane	Multiple
R307447	-	7/8"	1 1/2"	2 3/4"	2	Spring Eye	Polyurethane	Cambria
R303563	-	1 1/16"	1 5/8"	3 3/16"	2	Spring Eye Bracket	Polyurethane	Freightliner
R307841	G-7841	1 3/4"	2 1/2"	2 1/2"	2	Spring Eye	Rubber	Peterbilt
R304775	G-4775	1 3/4"	2 1/2"	2 3/4"	2	Spring Eye	Rubber	Peterbilt
R307509	-	1 3/4"	2 1/2"	2 3/4"	2	Spring Eye	Polyurethane	Peterbilt
R307701	-	2 1/4"	2 3/4"	2 9/32"	2	Equalizer	Polyurethane	Freightliner, Flanged End
R303540A	-	2 1/4"	2 3/4"	2 3/8"	2	Equalizer	Polyurethane	Freightliner, Flanged End
R307427	-	2 3/8"	3 5/8"	1 7/8"	2	Torque Arm	Polyurethane	Chalmers, Standard
R304745	-	2 1/2"	3 1/8"	2 1/4"	2	Equalizer	Injected Urethane	Peterbilt, Flanged End
R307510	-	2 1/2"	3 1/8"	2 1/4"	2	Equalizer	Cast Urethane	Peterbilt, Flanged End
R307426	-	2 1/2"	4 1/4"	2 1/8"	2	Torque Arm	Polyurethane	Chalmers
R308917	-	2 1/2"	4 1/2"	2 1/16"	2	Torque Arm	Polyurethane	Chalmers

SUSPENSION BUSHINGS

Suspension

Listed by Type, Then by ID

TYPE 1 One-Piece	TYPE 2 Straight Two-Piece	TYPE 3 Straddle Mount	TYPE 4 Tapered Two-Piece	TYPE 5 Tapered Stud	TYPE 6 Hendrickson Center Bushing	TYPE 7 Rubber Bushing
						
One bushing is required to service one component or one component end.	Two bushings are required to service one component or component end.	Length on guide is center-to-center.	Two bushings are required to service one component or component end. OD is larger dia.	Length on guide is stud shoulder length; ID is thread size.	Small OD is measured first.	ID on the guide is Pin Diameter

MERITOR NO.	MACH NO.	ID	OD	LENGTH	TYPE	END COMPONENT	MATERIAL	APPLICATION / NOTES
R309440	-	3 7/16"	4 1/2"	4"	2	Trunnion	Rubber	Ridewell Dynalastic
R309874	G-9874	N/A	1 3/4"	5 3/8"	3	Spring Eye	Rubber/Steel	Freightliner, 5/8" Bolt Holes
R305275	-	N/A	2"	4 3/8"	3	Torque Arm	Rubber/Steel	5/8" Bolt Holes
R3010322	-	N/A	2"	4 3/8"	3	Torque Arm	Rubber/Steel	3/4" Bolt Holes
R3016466	-	N/A	2"	4 3/8"	3	Torque Arm	Rubber/Steel	7/8" Bolt Holes
R3010320	-	N/A	2"	5 11/16"	3	Torque Arm	Rubber/Steel	3/4" Bolt Holes
R3014641	-	N/A	2 3/8"	4 3/8"	3	Torque Arm	Rubber/Steel	5/8" Bolt Holes
R3014644	-	N/A	2 3/8"	4 3/8"	3	Torque Arm	Rubber/Steel	3/4" Bolt Holes
R3014642	-	N/A	2 3/8"	5 1/4"	3	Torque Arm	Rubber/Steel	7/8" Bolt Holes
R3016094	G-16094	N/A	2 3/8"	4 3/8"	3	Spring Eye, High Confinement	Rubber/Steel	Peterbilt, 5/8" Bolt Holes
R302225	-	N/A	2 17/32"	4 3/8"	3	Torque Arm	Rubber/Steel	5/8" Bolt Holes
R307638	-	N/A	2 17/32"	4 3/8"	3	Torque Arm	Polyurethane/Steel	5/8" Bolt Holes
R3015671	G-15671	N/A	2 1/2"	4 3/8"	3	Spring Eye, High Confinement	Rubber/Steel	Mack, Volvo, 5/8" Bolt Holes
R3014026	-	N/A	2 1/2"	5 1/2"	3	Center Beam	Rubber/Steel	3/4" Bolts
R308804	G-8804	N/A	2 1/2"	5 21/32"	3	Spring Eye	Rubber/Steel	3/4" Bolt Holes
R3015541	G-15541	N/A	2 1/2"	5 11/16"	3	Spring Eye, Anti Walk	Rubber/Steel	Freightliner, Navistar, Peterbilt, 3/4" Bolt Holes
-	G-15600	N/A	2 9/16"	5 11/16"	3	Spring Eye, Oversize OD, Anti Walk	Rubber/Steel	Freightliner, Navistar, Peterbilt, 3/4" Bolt Holes
R304664	-	N/A	2 3/4"	4 3/8"	3	Torque Arm	Rubber/Steel/Alum.	5/8" Bolts , Aluminum Pin
R303868	-	N/A	2 3/4"	4 3/8"	3	Torque Arm	Rubber/Steel	3/4" Bolt Holes
R302226	-	N/A	2 3/4"	4 3/8"	3	Torque Arm	Rubber/Steel	5/8" Bolt Holes
R307639	-	N/A	2 3/4"	4 3/8"	3	Torque Arm	Polyurethane/Steel	5/8" Bolt Holes
R3010303	G-10303	N/A	2 3/4"	4 3/8"	3	Torque Arm	Rubber/Steel, High Confinement	Kenworth, 5/8" Bolt Holes
R302814	-	N/A	2 3/4"	5 11/16"	3	Torque Arm	Rubber/Steel	3/4" Bolt Holes
R303411	-	N/A	3"	5 11/16"	3	Torque Arm	Rubber/Steel	3/4" Bolt Holes
R3013970	-	N/A	3 1/4"	4 3/8"	3	Torque Rod	Rubber/Steel	Hendrickson Ultra Rod PLUS, 3/4" Bolt Holes
R3013971	-	N/A	3 1/4"	5 1/4"	3	Torque Rod	Rubber/Steel	Hendrickson Ultra Rod PLUS, 7/8" Bolt Holes
R309324	G-9324	N/A	3 1/2"	4 3/8"	3	Torque Arm	Rubber/Steel	5/8" Bolt Holes
R309288	-	N/A	3 3/4"	7 7/8"	3	Front Beam	Rubber/Steel	7/8" Bolt Holes
R309287	-	N/A	3 3/4"	7 7/8"	3	Rear Beam	Rubber/Steel	7/8" Bolt Holes
R3010678	-	N/A	3 7/8"	8 1/2"	3	Beam Bar Pin	Rubber/Steel	Neway, 1" Bolt Holes
R3016636	-	N/A	3 15/16"	8 1/2"	3	Beam Bar Pin	Rubber/Steel	Neway, 1" Bolt Holes

SUSPENSION BUSHINGS







Listed by Type, Then by ID

TYPE 1 One-Piece	TYPE 2 Straight Two-Piece	TYPE 3 Straddle Mount	TYPE 4 Tapered Two-Piece	TYPE 5 Tapered Stud	TYPE 6 Hendrickson Center Bushing	TYPE 7 Rubber Bushing		
								
One bushing is required to service one component or one component end.	Two bushings are required to service one component or component end.	Length on guide is center-to-center.	Two bushings are required to service one component or component end. OD is larger dia.	Length on guide is stud shoulder length; ID is thread size.	Small OD is measured first.	ID on the guide is Pin Diameter		
MERITOR NO.	MACH NO.	ID	OD	LENGTH	TYPE	END COMPONENT	MATERIAL	APPLICATION / NOTES
R309321	-	N/A	4 1/8"	5 1/4"	3	Torque Arm	Rubber/Steel	3/4" Bolt Holes
R308655	-	N/A	4 1/8"	5 1/4"	3	Torque Arm	Polyurethane/Steel	3/4" Bolt Holes
R309322	-	N/A	4 1/8"	5 1/4"	3	Torque Arm	Rubber/Steel	1" Bolt Holes
R309325	-	N/A	4 3/8"	8 1/2"	3	Beam End	Rubber/Steel	1" Bolt Holes, No Alignment Features
R3014725	-	N/A	4 3/4"	8 1/2"	3	Beam End	Rubber/Steel	Rotating Pin For Easy Alignment
R309326	-	N/A	4 3/4"	8 1/2"	3	Beam End	Rubber/Steel	Shim Type for Alignment
R307528	-	3/4"	1 7/16"	7/8"	4	Shock	Polyurethane	Multiple
R304403	-	3/4"	1 17/32"	13/16"	4	Shock	Rubber/Steel	Neway
R308684	-	3/4"	1 17/32"	15/16"	4	Shock	Polyurethane/Steel	Neway
R303296	-	3/4"	2 5/32"	1 3/16"	4	Torque Arm	Polyurethane	Freightliner
R301982	G-1982	1"	1 3/4"	2 11/16"	4	Torque Arm	Rubber/Steel	Reyco, Spicer
R307522	-	1"	1 3/4"	2 11/16"	4	Torque Arm	Polyurethane/Steel	Reyco
R301038	-	1"	1 3/4"	3 1/8"	4	Torque Arm	Rubber/Steel	Hutchens
R301964	G-1964	1"	1 13/16"	2 7/8"	4	Torque Arm	Rubber/Steel	Reyco/Eccentric ID
R308689	-	1"	1 13/16"	2 7/8"	4	Torque Arm	Polyurethane/Steel	Reyco/Eccentric ID
R301160	G-1160	1"	1 13/16"	3"	4	Torque Arm	Rubber/Steel	Reyco 21B
R307523	-	1"	1 13/16"	3"	4	Torque Arm	Polyurethane/Steel	Reyco 21B
R307529	-	1"	1 7/8"	1"	4	Shock	Polyurethane	Multiple
R30401754	-	1"	1 7/8"	1"	4	Shock	Rubber	Multiple
R3010057	G-10057	1"	3 1/16"	2 7/8"	4	Torque Arm	Rubber/Steel	Reyco
R309579	-	1"	3 1/16"	2 7/8"	4	Torque Arm	Polyurethane/Steel	Reyco
R3016505	-	1 1/4"	2 3/16"	2 3/8"	4	Torque Arm	Rubber/Steel	Fruehauf, Hutchens - Genuine
R30927	G-927	1 1/4"	2 3/16"	2 3/8"	4	Torque Arm	Rubber/Steel	Fruehauf, Hutchens
R307433	-	1 1/4"	2 3/16"	2 3/8"	4	Torque Arm	Polyurethane/Steel	Fruehauf, Hutchens
R301159	-	1 5/8"	3 3/8"	4 13/32"	4	Equalizer	Rubber/Steel	Reyco 21B
R308653	-	1 5/8"	3 3/8"	4 13/32"	4	Equalizer	Polyurethane/Steel	Reyco 21B
R301984	-	1 3/4"	3 5/8"	4 1/16"	4	Equalizer	Rubber/Steel	Dana
R301020	G-1020	2"	3 1/2"	4 3/8"	4	Equalizer	Rubber/Steel	Fruehauf
R307432	-	2"	3 1/2"	4 3/8"	4	Equalizer	Polyurethane/Steel	Fruehauf
R30813	-	2 3/8"	4 1/16"	2 9/16"	4	Equalizer	Rubber	Reyco 21
R308691	-	2 3/8"	4 1/16"	2 9/16"	4	Equalizer	Polyurethane	Reyco 21
R304257	-	2 9/16"	3 13/16"	2 5/8"	4	Beam Bushing	Rubber/Steel	Neway
R308682	-	2 9/16"	3 13/16"	2 5/8"	4	Beam Bushing	Polyurethane/Steel	Neway
R307457	-	3"	5 21/32"	2 7/8"	4	Suspension	Polyurethane	Hyster
R3010308	-	1 1/8"-12	2"	2"	5	Torque Arm	Rubber/Steel	Hendrickson Ultra Rods
R302227	-	1 1/8"-12	2 17/32"	2"	5	Torque Arm	Rubber/Steel	Multiple

SUSPENSION BUSHINGS

Suspension

Listed by Type, Then by ID

TYPE 1 One-Piece	TYPE 2 Straight Two-Piece	TYPE 3 Straddle Mount	TYPE 4 Tapered Two-Piece	TYPE 5 Tapered Stud	TYPE 6 Hendrickson Center Bushing	TYPE 7 Rubber Bushing
						
One bushing is required to service one component or one component end.	Two bushings are required to service one component or component end.	Length on guide is center-to-center.	Two bushings are required to service one component or component end. OD is larger dia.	Length on guide is stud shoulder length; ID is thread size.	Small OD is measured first.	ID on the guide is Pin Diameter

MERITOR NO.	MACH NO.	ID	OD	LENGTH	TYPE	END COMPONENT	MATERIAL	APPLICATION / NOTES
R302916	-	1 1/8"-12	2 3/4"	2"	5	Torque Arm	Rubber/Steel	Multiple
R3014643	-	1 1/4"-12	2 3/4"	3"	5	Torque Arm	Rubber/Steel	Hendrickson Ultra Rod Plus
R3013969	-	1 1/8"-12	3 1/4"	1 7/8"	5	Torque Rod	Rubber/Steel	Hendrickson Ultra Rod Plus
R3010321	-	1 1/4"-12	2"	1 7/8"	5	Torque Arm	Rubber/Steel	Hendrickson Ultra Rods
R3010309	-	1 1/4"-12	2"	3"	5	Torque Arm	Rubber/Steel	Hendrickson Ultra Rods
R302815	-	1 1/4"-12	2 3/4"	1 7/8"	5	Torque Arm	Rubber/Steel	Multiple
R309518	-	1 1/4"-12	2 3/4"	1 7/8"	5	Torque Arm	Polyurethane/Steel	Multiple
R302228	-	1 1/4"-12	2 3/4"	3"	5	Torque Arm	Rubber/Steel	Multiple
R308651	-	1 1/4"-12	2 3/4"	3"	5	Torque Arm	Polyurethane/Steel	Multiple
R3013965	-	1 1/4"-12	3 1/4"	1 7/8"	5	Torque Rod	Rubber/Steel	Hendrickson Ultra Rod Plus
R3013962	-	1 1/4"-12	3 1/4"	3"	5	Torque Arm	Rubber/Steel	Hendrickson Ultra Rod Plus
R3013972	-	1 3/4"-12	3 1/4"	3"	5	Torque Rod	Rubber/Steel	Hendrickson Ultra Rod Plus
R301338	-	1 5/16"	2 3/4" SM; 3 5/8" LG	12"	6	Center Beam	Rubber/Steel	Hendrickson, Welded Plug
R301594	-	1 5/16"	2 3/4" SM; 3 5/8" LG	12"	6	Center Beam	Rubber/Steel	Hendrickson, Loose Plug
R301339	-	2 7/16"	3 1/2" SM; 4 3/4" LG	12"	6	Center Beam	Rubber/Steel	Hendrickson, Welded Plug
R301595	-	2 7/16"	3 1/2" SM; 4 3/4" LG	12"	6	Center Beam	Rubber/Steel	Hendrickson, Loose Plug
R306979	-	2 7/16"	3 1/2" SM; 4 3/4" LG	12"	6	Center Beam	Rubber/Steel	Hendrickson High Confinement, Welded Plug
R306980	-	2 7/16"	3 1/2" SM; 4 3/4" LG	12"	6	Center Beam	Rubber/Steel	Hendrickson High Confinement, Loose Plug
R309510	-	2 7/16"	3 1/2" SM; 4 3/4" LG	12"	6	Center Beam	Polyurethane/Steel	Welded Plug
R309359	-	2 7/16"	3 1/2" SM; 4 3/4" LG	12"	6	Center Beam	Rubber/Steel	Hendrickson Severe Duty, Welded Plug
R3016416	-	2 7/16"	3 1/2" SM; 4 3/4" LG	12"	6	Center Beam	Rubber/Steel	Hendrickson Severe Duty, Loose Plug
R302553	-	3"	4" SM; 5 1/2" LG	14 5/8"	6	Center Beam	Rubber/Steel	Hendrickson Severe Duty, Welded Plug
R3014398	-	3"	4" SM; 5 1/2" LG	18"	6	Center Beam	Rubber/Steel	Hendrickson, Welded Plug
R3015543	G-15543	1 1/16" Dia Pin	1 3/4"	6 11/16"	7	Spring Eye	Rubber/Steel	Kenworth Front, 5 7/16" Center-to-Center
R3016292	G-16292	1 1/16" Dia Pin	1 3/4"	7 1/8"	7	Spring Eye	Rubber/Steel	Kenworth Front, 5 3/4" Center-to-Center
R3015537	G-15537	1 1/16" Dia Pin	1 3/4"	7 1/2"	7	Spring Eye	Rubber/Steel	Kenworth Front, 6 3/16" Center-to-Center
R3015613	G-15613	1 1/16" Dia Pin	2 1/16"	7 1/2"	7	Spring Eye	Rubber/Steel	Kenworth Front, 6 5/16" Center-to-Center
R3016163	G-16163	1 1/16" Dia Pin	2 1/16"	6 11/16"	7	Spring Eye	Rubber/Steel	Kenworth Front, 5 7/16" Center-to-Center

SPRING PINS

Sorted by Diameter

SRPING PINS

Smooth Spring Pins, One Lock Pin Notch



MERITOR NO.	DIAMETER	LENGTH	PRIMARY APPLICATION
R301817	1 1/4"	7 5/16"	Hendrickson
R301818	1 3/8"	7 5/16"	Hendrickson
R302556	1 1/2"	7 1/2"	Hendrickson

Smooth Spring Pins, Two Lock Pin Notches, Center Grease Groove



MACH NO.	DIAMETER	LENGTH	C-TO-C	PRIMARY APPLICATION
G-15655	1"	6 5/16"	4 15/16"	Navistar
G-15597	1 3/8"	6"	4 1/4"	Freightliner
G-15644	1 1/4"	6 1/2"	5 1/8"	Navistar
G-16305	1 1/4"	6 3/4"	5"	Navistar

Smooth Spring Pins, Two Lock Pin Notches, Non-Centered Grease Groove

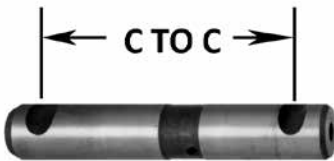

MERITOR NO.	MACH NO.	DIAMETER	LENGTH	C-TO-C	PRIMARY APPLICATION
R308796	G-8796	1 1/4"	6 7/8"	5 3/8"	Freightliner

SPRING PINS

Sorted by Diameter

Suspension

SPRING PINS

Smooth Spring Pins, Two Notches, Flat Groove on Top, Grease Groove in Line with Lock Pin Notches



MERITOR NO.	MACH NO.	DIAMETER	LENGTH	C-TO-C	PRIMARY APPLICATION
-	G-15666	1 1/8"	7"	5 1/2"	Volvo
R303761	-	1 3/8"	6 7/8"	5 3/8"	Hendrickson
-	G-15646	1 1/4"	5 5/16"	4"	Navistar
-	G-15645	1 1/4"	5 9/16"	4"	Navistar
R3012001	-	1 1/2"	8 1/2"	7 1/8"	Hendrickson
R303530	G-3530	1 1/4"	5 3/4"	4 1/2"	Freightliner
R303531	G-3531	1 1/2"	6 3/8"	4 7/8"	Freightliner

Smooth Spring Pins, Two Notches, Grease Groove 90 Degrees vs. Lock Pin Notches



MACH NO.	DIAMETER	LENGTH	C-TO-C	PRIMARY APPLICATION
G-15661	1 1/4"	5 5/8"	4 7/16"	Peterbilt
G-15662	1 1/4"	6"	5 1/16"	Peterbilt
G-16319	1 1/4"	6 7/8"	5 5/16"	Kenworth, Peterbilt

SPRING PINS

Sorted by Diameter

SRPING PINS

Smooth Spring Pins, Flats on Both Ends

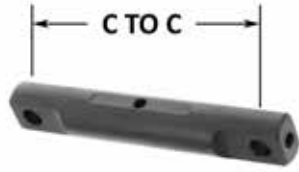

MACH NO.	DIAMETER	LENGTH	C-TO-C	BOLT HOLE	PRIMARY APPLICATION
G-15663	1 1/4"	7 3/4"	5 9/16"	1/2"	Peterbilt

Smooth Spring Pins



MERITOR NO.	DIAMETER	LENGTH	PRIMARY APPLICATION
R303715	1 3/4"	6 1/4"	Mack

Threaded Spring Pins, Same Diameter Both Ends, Grease Groove Aligned with Lock Pin Notches



MACH NO.	END DIAMETER	LENGTH	C-TO-C	THREAD	PRIMARY APPLICATION
G-15640	1"	7 3/8"	5 3/4"	1 3/8"-6	Navistar
G-16321	1 1/16"	7"	5 7/16"	M33.5 -4.0	Kenworth, Peterbilt
G-16703	1 1/16"	7 1/4"	5 3/4"	1 3/8"-6	Kenworth
G-15614	1 1/16"	7 3/8"	5 3/4"	M33.5 -4.0	Kenworth, Peterbilt
G-15620	1 1/16"	7 7/8"	5 5/16"	M33.5 -4.0	Kenworth, Peterbilt

SPRING PINS

Suspension

Sorted by Diameter

SPRING PINS

Threaded Spring Pins, Same Diameter Both Ends, Grease Groove 90 Degrees vs. Lock Pin Notches



MERITOR NO.	END DIAMETER	LENGTH	C-TO-C	THREAD	PRIMARY APPLICATION
R303717	1 5/16"	6 9/16"	5"	1 3/8"-6	Mack

Threaded Spring Pins, Large and Small Ends



Grease Fitting Large End Except for G-15619

MERITOR NO.	MACH NO.	LARGE END DIAMETER	SMALL END DIAMETER	LENGTH	C-TO-C	THREAD	PRIMARY APPLICATION
-	G-3532	1 1/4"	1"	6 1/8"	4 7/8"	1 1/4"-8	Freightliner
R308800	G-8800	1 1/4"	1"	7 1/8"	5 3/8"	1 1/4"-8	Freightliner
-	G-15619	1 1/2"	1 1/16"	7 3/8"	5 3/4"	1 3/8"-6	Kenworth
-	G-15648	1 1/2"	1 1/16"	7 3/8"	5 3/4"	1 3/8"-6	Navistar

SPRING EYE BUSHINGS

By Outside Diameter

SRPING EYE
BUSHINGS

Bi-Metal Bushings



MERITOR NO.	MACH NO.	OD	ID	LENGTH	PRIMARY APPLICATION
-	G-16141	1 3/8"	1 1/8"	3"	Oshkosh
R3016167	G-16167	1 1/2"	1 1/4"	3 1/2"	Mack, Peterbilt
R301876	-	1 1/2"	1 1/4"	4"	Freightliner, Kenworth, Peterbilt
R3016153	-	1 1/2"	1 1/4"	4"	Kenworth, Peterbilt (Includes Inner Grease Seals)

Bronze Bushings



MERITOR NO.	MACH NO.	OD	ID	LENGTH	PRIMARY APPLICATION
R303533	-	1 1/2"	1 1/4"	3 1/2"	Freightliner, Mack
R308797	G-8797	1 5/8"	1 1/4"	4"	Freightliner

SPRING EYE BUSHINGS

By Outside Diameter

Suspension

SPRING EYE
BUSHINGS

Threaded Bushings



MERITOR NO.	MACH NO.	OD	LENGTH	THREAD	PRIMARY APPLICATION
R308799	G-8799	1 1/2"	4"	1 1/4"-8	Freightliner
-	G-3534	1 1/2"	3 1/2"	1 1/4"-8	Freightliner
-	G-15538	1 3/4"	8"	1 3/8"-6	Kenworth
-	G-16157	1 3/4" (44.5mm)	4" (101mm)	M33.5 -4.0	Peterbilt
-	G-15667	1 3/4"	4 1/8"	M32-4.0	Volvo
-	G-16158	2 1/16" (52.8mm)	4" (101mm)	M33.5 -4.0	Peterbilt

Rubber Bushings

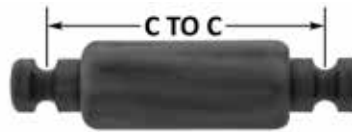

MERITOR NO.	MACH NO.	OEM REF	OD	PIN DIA	OVERALL LENGTH	C-T-C
R3015543	G-15543	B65-6005	1 3/4"	1 1/16"	6 11/16"	5 7/16"
R3016292	G-16292	B65-1001	1 3/4"	1 1/16"	7 1/8"	5 3/4"
R3015537	G-15537	B65-1006	1 3/4"	1 1/16"	7 1/2"	6 3/16"
R3016163	G-16163	B65-1013; B65-6006	2 1/16"	1 1/16"	6 11/16"	5 7/16"
R3015613	G-15613	B65-1007	2 1/16"	1 1/16"	7 1/2"	6 5/16"

HEIGHT CONTROL VALVES

Purpose & Features

The purpose of the Height Control Valve (HCV) is to maintain the desired ride height of the truck/tractor or trailer by adding or removing air from the air springs. A linkage connects the vehicles axle to the HCV which is mounted to the vehicle frame. When the distance between the axle and frame changes, the linkage moves the HCV thereby adding or removing air from the air springs.

Features of HCV

- Dump or no dump of air to air spring when required
- Proportional or non-proportional output
- Immediate vs. Delayed response
- Arm length / Offset
- Linkage
- Brackets
- Mounting Orientation
- Fitting types

Key Components

Some of these components are included when a valve is purchased and some components can often be reused (especially mounting brackets and linkage) so consider the need for all of these components when replacing a valve

- Valve (Body)
- Arm
- Mounting Bracket
- Linkage

Typical Barksdale Valve

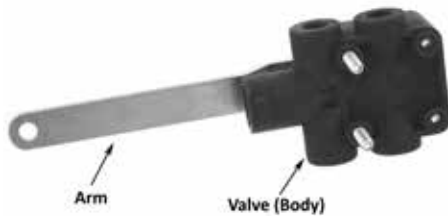

Popular Hadley Valve



Common Brackets & Linkage



Some of these components are included with specific valves. Mounting brackets and linkage can often be reused so consider the need for all of these components when replacing a valve.

HEIGHT CONTROL VALVES

Definitions

- Dump Feature** – In addition to "automatically" controlling the air flow to the air springs to control the ride height of the vehicle, some height control valves can also dump the air from the air springs under certain conditions such as when the vehicle is parked. This feature requires a separate air line from either a dash/dump control or from the air system for the air brakes.
 - Dump valves can operate in one of two manners.
 - Dump valve opens when pressure is applied to the dump port. In this case the air line to the dump port is typically connected to a button located on the dash board. When activated by the driver, this provides the air pressure necessary to actuate the dump feature in the HCV and dump air to the air springs.
 - Dump valves opens when pressure is removed from the dump port. The dump port is on these valves is connected to the air brake system so when the brake pressure is dumped and the spring brakes are set, the dump feature in the HCV is actuated and it dumps air to the air springs.
- Proportional or non Proportional Output** – This is similar to a dimmer switch on your lights vs. an on-off switch. The proportional operation is used on most valves and provides more air flow to the air springs the further the arm moves from its center/off position. A few older style valves are non proportional and are "fully on" (like a light switch) whenever the arm moves to the point of allowing air to flow. Most of the non proportional valves are also delayed response (See below)
- Immediate or Delayed Response** – Most valves respond immediately to a change in ride height and begin to provide or release air to the air springs. A few valves, primarily older designs with non proportional output, incorporated a design feature which slows down the response so the valve was not constantly inputting or releasing air. This is the "delayed response". The delay feature typically uses a viscous liquid to slow down the movement of the valves components and the response time. However the viscosity of the liquid can be affected by temperature, especially in cold weather, which can disrupt the normal operation of the valve. Because of these potential issues and more advancements in valve designs, the more common valves do **not** use a delayed response. Throughout this catalog section, all proportional valves are immediate response and all non proportional valves are delayed response
- Arm Length** – For a valve to function in the optimum manner the arm length must match that of the OE application. Several valves have multiple holes in the arm for attaching the linkage which provides more flexibility and opportunities to match the OE design.
 - While a valve will operate with an arm length that is different than the OEM specification, it will not perform in the optimal manner.
 - Some valves have arms that can be removed and replaced. Barksdale valves have arms that should not be remove or replaced since this will alter the performance of the valve.
- Offset** – Every HCV application has an offset between the frame rail where the valve/bracket is mounted and the vertical position of the linkage. As with arm length, the proper offset is required for optimum performance. The mounting bracket, valve design and arm configuration all combine to determine the offset. If an exact replacement valve is used, then the offset is not an issue. If a different style of valve is used as a replacement, then use the necessary brackets and / or arms with the new valve to obtain the required offset.
- Linkage** – All HCVs have some type of linkage that attaches the valve arm to the axle. Depending upon the application, the linkage can be a simple straight steel or aluminum shaft with ends which attach to the valve and axle or may be a more complicated design which may be required to avoid interference with nearby components. If the linkage is not damaged and a "like for like" HCV is available, then the linkage can often be reused.
- Mounting Brackets** – Virtually every application requires some type of mounting bracket. These brackets allow the valve to be mounted to the frame rail in the proper location and orientation required for proper performance. These can typically be reused if they are not damaged and the new HCV will properly mount to the bracket. Most valves use ¼" diameter bolts or studs with a spacing of 1 ½" to mount to the bracket. Many universal HCV's include one or more brackets and provide a variety of mounting options.
- Mounting Orientation** – A few valves can be mounted either vertically or horizontally while others will operate properly only when mounted in one direction. Horizontal mounting is the most common.
- Fitting types** –A number of fitting types are available to provide the connection to the air tubing. ¼" NPT, compression fittings and the newer Push to Connect (PTC) options are the most common. Not every HCV will be available with every fitting type so adapters can be used when necessary to provide the desired connection.

HEIGHT CONTROL VALVES

Selection Process

Three steps are required to determine the proper valve.

Step 1) Determine if a dump valve is required,

Step 2) Select the valve manufacturer and model and

Step 3) Choose the proper arm length, offset, mounting style and brackets.

Step 1 – Determine the type of valve that is required. Does the HCV also need to dump air to the air springs when either:

- A. An actuation button is pushed on the dash or in some other location
- B. The air is removed from the brake system thereby locking the spring brakes

Is a Dump style valve is required?

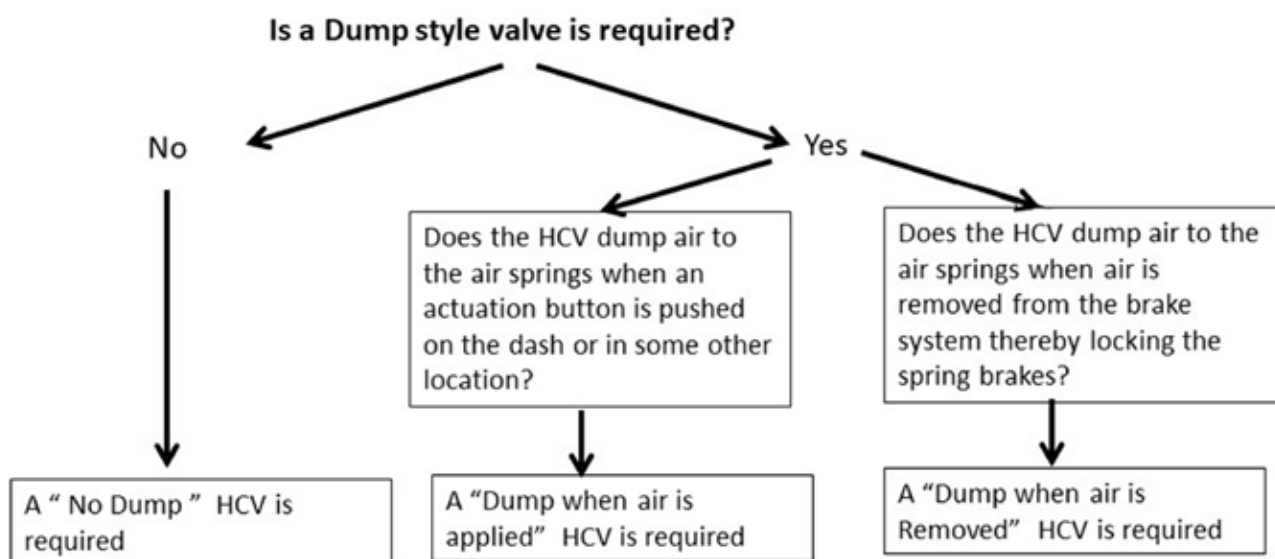

Step 2 – Is there a preferred manufacturer and model of the valve?

















There are three primary valve manufacturers in North America

- A. Barksdale
- B. Hadley
- C. Haldex

All three companies make valves that operate in a similar manner so if an exact replacement is desired, it MIGHT be available from your local dealer or distributor. Some "exact replacement" valves are only available from the specific vehicle OEM's & their dealers.

The most common valve models are shown on the following page.

If an exact replacement is not available, several "universal" valves will work in most applications and are shown on page 104. Many of these universal valves also include brackets and arms. The brackets allow the universal valve to be mounted in various manners and the arms will allow for a number of different offsets and arm lengths/mounting to the linkage.

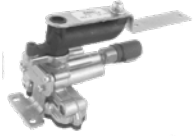
Height Control Valve Manufacturer and Model Identification		
NO DUMP	WITH INTEGRATED DUMP FEATURE - DUMP WHEN AIR PRESSURE IS APPLIED	WITH INTEGRATED DUMP FEATURE - DUMP WHEN AIR PRESSURE IS REMOVED
Barksdale Series And Description - Immediate Response		
 55521 Series Non Dump Valve - Plastic Body 52321 Series Non Dump Valve - Aluminum Body	 52341 Series, Integral Dump Feature	 54341 Series - Negative Air Pressure to Actuate Dump valve
Hadley Series and Description - Immediate Response		
 450 Series Non Dump Valve	 500 Series Dump Valve	 500 Series Reverse Actuation Dump Valve
 Next Gen Non Dump Valve	 Next Gen Pressure Dump Valve	 Next Gen Zero Pressure Dump Valve
Haldex Series and Description - Immediate Response		
 IR Series Non Dump Valve	 IR Series with Dump Valve	N/A
 PR Series Non Dump Valve	 PR Series w/ Normally Open Dump Valve	 PR Series w/ Normally Closed Dump Valve
Haldex Series and Description - Delayed Response		
 CR Series Non Dump Valve	 CR Series w/ Normally Open Dump	 CR Series w/ Normally Closed Dump Valve

VALVES & ACCESSORIES

N/A - Not Available

HEIGHT CONTROL VALVES

Selection Process (Continued)

Step 3 – Other Considerations

1. **Arm Length + Offset** – Match the Arm Length and Offset of the OEM Valve for optional performance
 - While a valve will operate with an arm length that is different than the OEM specification, it will not perform in the optimal manner.
 - The offset may be determined by the bracket and arms which may be flat or bent.
 - Some valves have arms that can be removed and replaced. Barksdale valves have arms that are permanently attached and can not be remove or replaced.
2. **Brackets/mountings** – Are available to allow for the proper mounting of the valve onto the vehicle. In many cases the brackets can be reused.
3. **Horizontal of vertical mounting** – Some valves can be mounted either vertically or horizontally while others will operate properly only when mounted in one direction. Horizontal mounting is most common and only specially noted valves can be mounted vertically.
4. **Immediate or Delayed Response and Proportional or Non Proportional Output** – Most of the latest valve designs do NOT have a delay and respond immediately to changes in ride height. In addition, most of the new designs have proportional output which provides more air flow to the air springs the further the arm moves from its center/off position. All of the immediate response valves offered by Meritor are proportional and all delayed response valves are non-proportional.
5. **Fittings** – Many different fittings are available but adapters can also be used to simplify the replacement process.

VALVES & ACCESSORIES

Meritor Offers Universal Height Control Valves Which Can Be Used In Most Applications

Universal Height Control Valves		
	MERITOR PART NO.	HADLEY MODEL
No Dump	R3014729	Next Gen
Applied Air To Dump	R3014731	Next Gen
Remove Air To Dump	R3014730	Next Gen

HEIGHT CONTROL VALVES

Plumbing Diagrams Of Typical Trailer Air System

NO DUMP

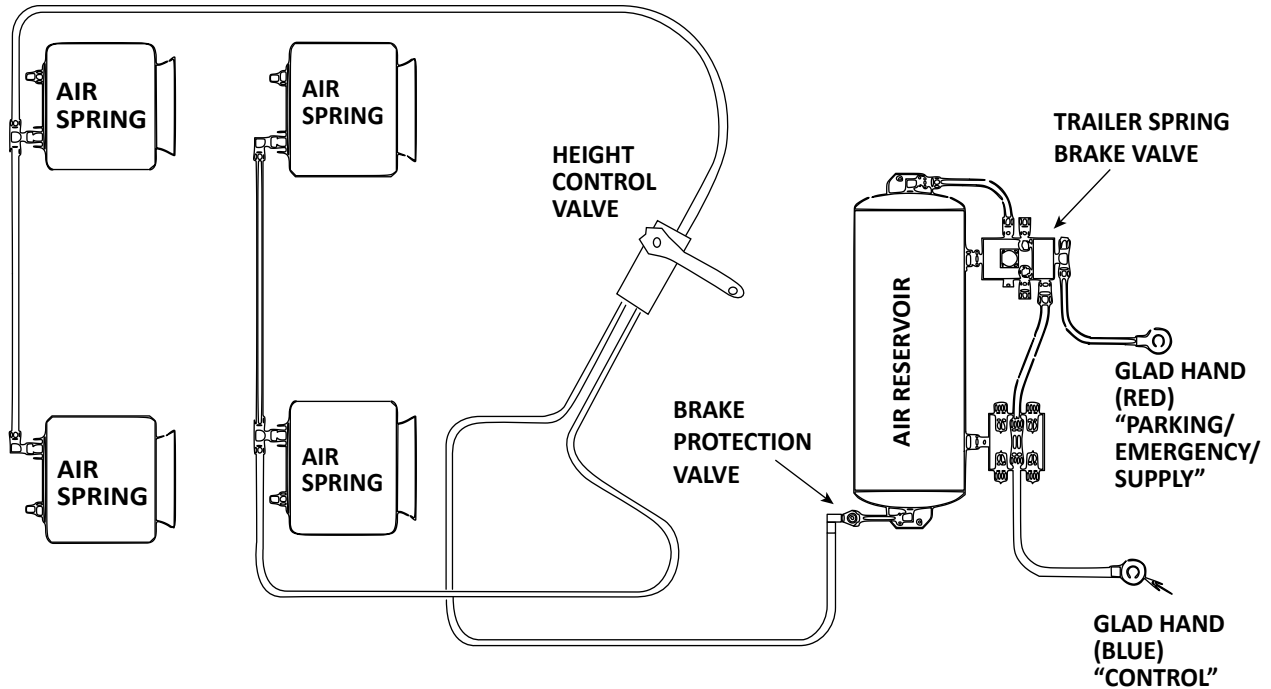

APPLY AIR TO DUMP

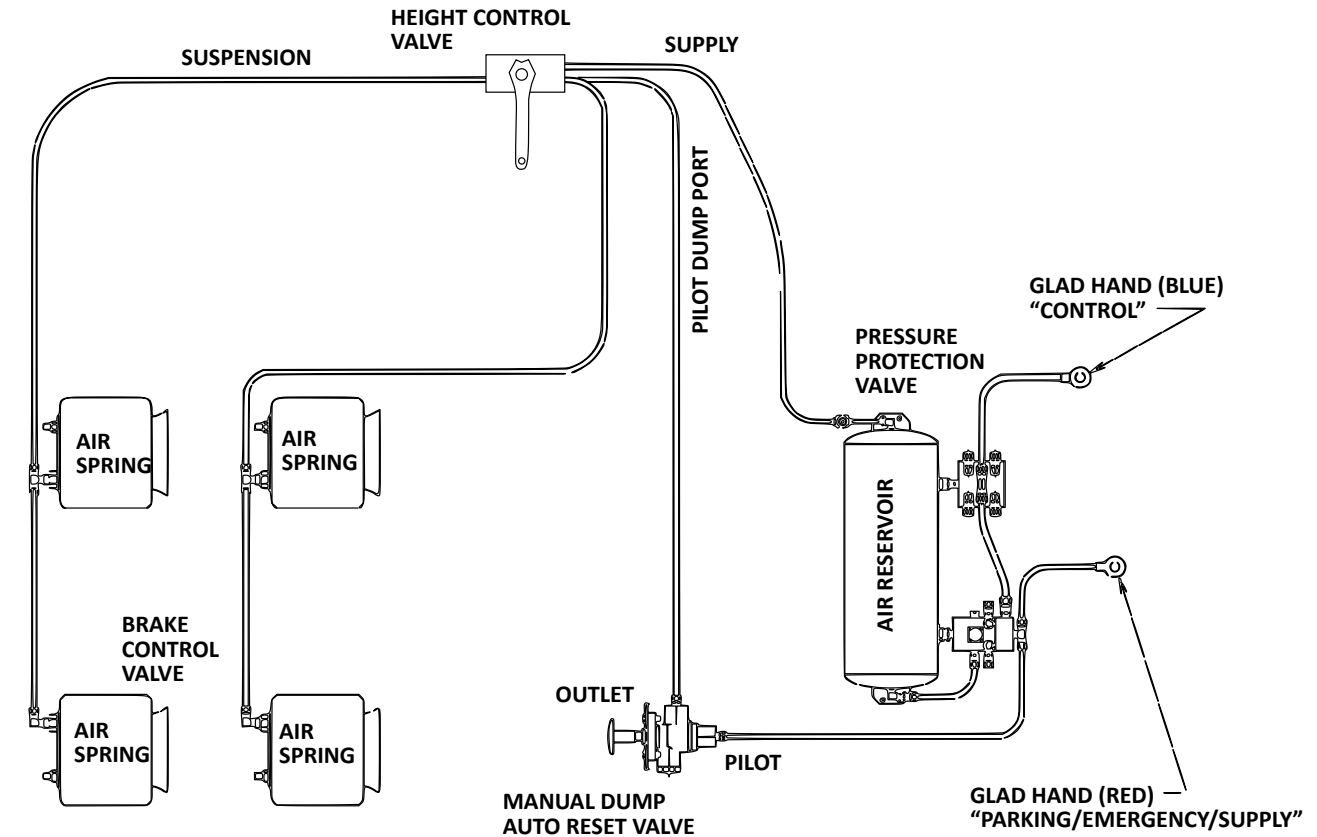

VALVES &
ACCESSORIES

HEIGHT CONTROL VALVES

Plumbing Diagrams Of Typical Trailer Air System

VALVES & ACCESSORIES

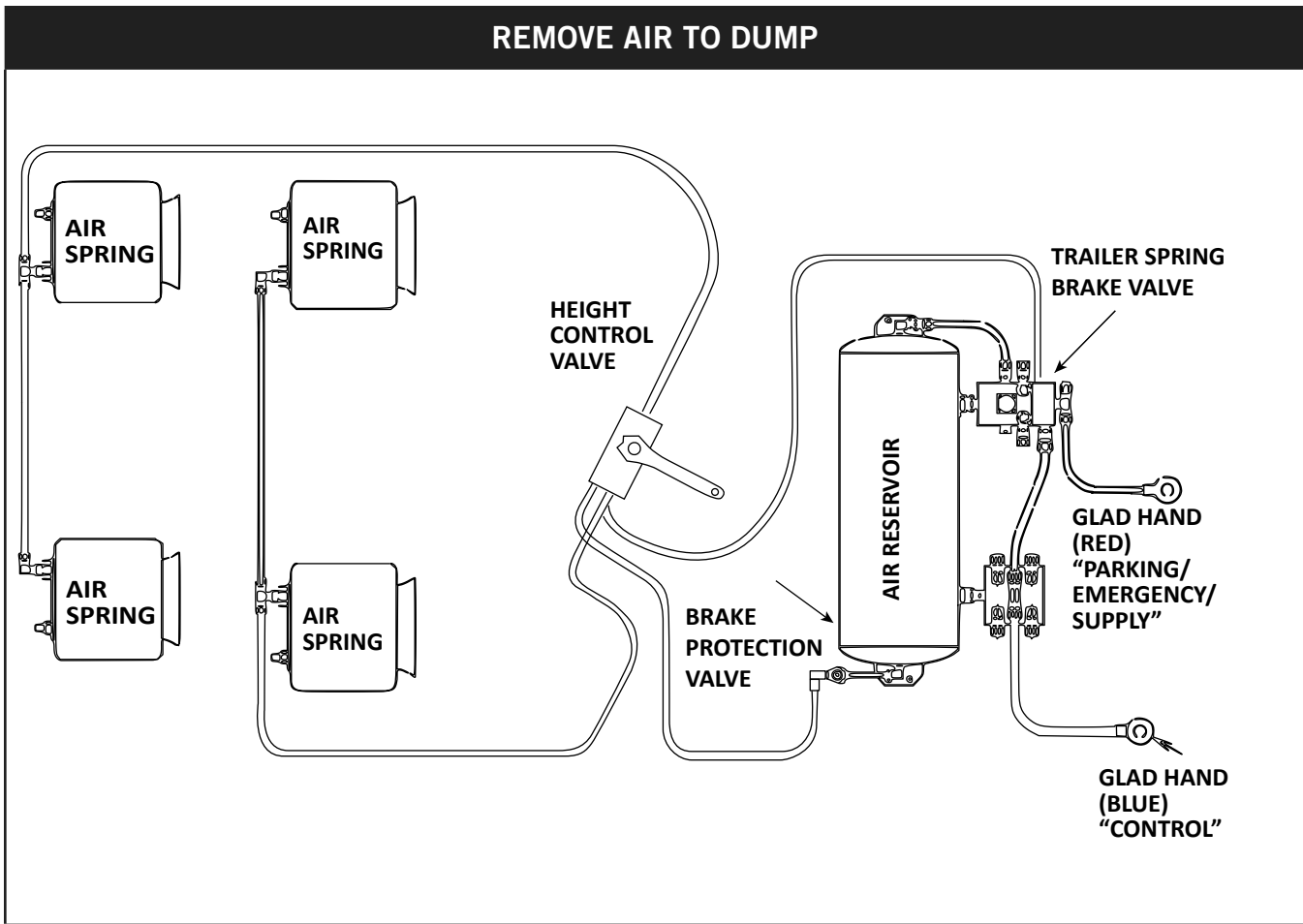

NOTE: Illustrations are for general informational purposes and may not reflect actual trailer or truck systems.

HEIGHT CONTROL VALVES

Suspension

Part Number Chart - No Dump Valves

No Dump

Barksdale

MERITOR NO.	OEM REF	MANUFACTURER MODEL/ PART NO.	ARM LENGTH	APPLICATION	FITTINGS / PORT SIZE	BRACKET INCLUDED	LINKAGE INCLUDED	VALVE ONLY MERITOR NO.
R3011494	60826-000	52321 Series	5", 6 7/8" & 7 1/2"	Hendrickson HA360, 400, 460 Air Ride	1/4" NPT	Yes	No	N/A
R3011855	VS-227	52321 Series	5", 7 3/8" & 8 1/2"	Hendrickson INTRAAX AND VANTRAAX	1/4" NPT	Yes	No	N/A
R3015130	60961-155	55521-Q141-320110	5 3/4"	Hendrickson AIRTEK® FOR INTERNATIONAL Dual HCV Conversion, Prior to 08/09	PTC	No	Yes	N/A
R3015151	59935-003	55521-Q116	5 3/4"	HENDRICKSON AIRTEK® FOR MACK VEHICLES, Prior to 03/05	PTC	No	No	-
R3014013	64089-000	55521-Q116-32071	5 3/4"	HENDRICKSON AIRTEK® FOR MACK VEHICLES, Prior to 03/05 w/12 & 12.5K Axles	PTC	Yes	Yes	R3015151
R3014014	64094-000	55521 Series	5 3/4"	HENDRICKSON AIRTEK® FOR MACK VEHICLES, Prior to 03/05 w/13.2 & 14.6K Axles	PTC	Yes	Yes	R3015151
R3013996	59935-011	55521-Q160	6"	Hendrickson AIRTEK® FOR INTERNATIONAL IC Buses, Right Hand	PTC	No	No	-
R3013995	59935-002	55521-Q115	7"	Hendrickson AIRTEK® w/ STEERTEK Axle for Freightliner and Western Star, Right Hand	PTC	No	No	-
R3017088	59935-013	55521-Q150	7"	Hendrickson AIRTEK® w/ STEERTEK NXT Axle for Freightliner and Western Star, Left Hand	PTC	No	No	-
R3017089	59935-024	55521-Q183	7"	Hendrickson AIRTEK® w/ STEERTEK NXT Axle for Freightliner and Western Star, Right Hand	PTC	No	No	-





N/A - Not Available

Note: Photos represent a valve of the manufacturer and model for this section. The actual part number may also contain brackets and/or linkage. See photo section starting at page 112 for pictures of each individual part number



HEIGHT CONTROL VALVES

Part Number Chart - No Dump Valves

VALVES & ACCESSORIES

No Dump									
Hadley									
	MERITOR NO.	OEM REF	MANUFACTURER MODEL/ PART NO	ARM LENGTH	APPLICATION	FITTINGS	BRACKET INCLUDED	LINKAGE INCLUDED	VALVE ONLY MERITOR NO.
	R309623	H00450CE	450 Series	7"	Various	1/4" Compression	Yes	No	N/A
	R3015271	23329-01	450 Series	7"	Reyco	1/4" Compression	Yes	Yes	N/A
	A-7806-L-1052	-	Next Gen	5 1/2"	Meritor MTA Top Mount	3/8" PTC	No	No	-
	KIT11309	-	Next Gen	9"	Meritor RHP	3/8" PTC	No	Yes	N/A
	KIT11333	-	Next Gen	9"	Meritor RideSentury MPA	3/8" PTC	No	Yes	N/A
	R3014729	-	Next Gen	7", 8", & 9"	Universal	3/8" PTC	No	No	-

N/A - Not Available

No Dump									
Haldex									
	MERITOR NO.	OEM REF	MANUFACTURER MODEL/ PART NO	ARM LENGTH	APPLICATION	FITTINGS	BRACKET INCLUDED	LINKAGE INCLUDED	VALVE ONLY MERITOR NO.
	R3013922	90555105, 90554241	IR Series	Adjustable	Neway	1/4" NPT	Yes	Yes	N/A
	R304323	90054007	CR Series	7"	Neway	1/8" NPT	Yes	No	N/A
	R3013917	90554945	PR Plus Series	7"	Neway	1/4" NPT	No	No	-
	R3013920	90555273	PR Plus Series	7"	Neway	3/8" PTC	No	No	-
	R3013919	90555085	PR Plus Series	7"	Neway	M12 x 1.5	No	No	-

N/A - Not Available

Note: Photos represent a valve of the manufacturer and model for this section. The actual part number may also contain brackets and/or linkage. See photo section starting at page 112 for pictures of each individual part number.

HEIGHT CONTROL VALVES

Part Number Chart - Apply Air To Dump Valves



Suspension

Apply Air To Dump

Barksdale									
	MERITOR NO.	OEM REF	MANUFACTURER MODEL/ PART NO	ARM LENGTH	APPLICATION	FITTINGS	BRACKET INCLUDED	LINKAGE INCLUDED	VALVE ONLY MERITOR NO.
	R3016417	66277-001	52341-Q211-320136	5 3/4"	Hendrickson Airtek for Spartan Motorhome Chassis with Drum Brakes, Left Hand	3/8" PTC	No	Yes	N/A
	R3016418	66277-002	52341-Q212-320136	5 3/4"	Hendrickson Airtek for Spartan Motorhome Chassis with Drum Brakes, Right Hand	3/8" PTC	No	Yes	N/A
	R3016407	60501-000	52341-Q123	7"	HENDRICKSON PARASTEER/ BlueBird	1/4" NPT	No	No	-
	R3011870	57977-000	060501-000; 52341-Q123	7"	Hendrickson AR2	1/4" NPT	Yes	No	R3016407

N/A - Not Available

Apply Air To Dump



Hadley									
	MERITOR NO.	OEM REF	MANUFACTURER MODEL/ PART NO	ARM LENGTH	APPLICATION	FITTINGS	BRACKET INCLUDED	LINKAGE INCLUDED	VALVE ONLY MERITOR NO.
	A-7806-Y-1013	-	500 Series/ H00500DB	6 1/4"	Meritor RFS	1/4" NPT	No	No	-
	KIT11207	-	500 Series	6 1/4"	Meritor RFS	1/4" NPT	No	Yes	KIT11207
	R309624	-	500 Series/ H00500C	3", 5", 9"	Meritor M311501	1/4" NPT	Yes	No	N/A
	R3011465	-	500 Series/ H00500CB	9"	-	1/4" Compression	Yes	No	N/A
	R3014732	-	Next Gen	7", 8", 9"	Universal	1/4" PTC	No	No	-
	R3014731	-	Next Gen	7", 8", 9"	Universal	3/8" PTC	No	No	-
	A-7806-M-1053	-	Next Gen	5 1/2"	Meritor MTA Top Mount	3/8" PTC	No	No	N/A

N/A - Not Available

Note: Photos represent a valve of the manufacturer and model for this section. The actual part number may also contain brackets and/or linkage. See photo section starting at page 112 for pictures of each individual part number.

HEIGHT CONTROL VALVES

Part Number Chart - Apply Air To Dump Valves

Apply Air To Dump								
Haldex								
	MERITOR NO.	OEM REF	MANUFACTURER MODEL/PART NO	ARM LENGTH	FITTINGS	BRACKET INCLUDED	LINKAGE INCLUDED	VALVE ONLY MERITOR NO.
	R3013916	90555106	IR Series	ADJ.	1/4" NPT	No	No	-
	R3013918	90554950	PR Plus Series	7"	1/4" NPT & Pilot - 1/4" PTC	No	No	-
	R3013921	90555274	PR Plus Series	7"	1/4" NPT & Pilot - 1/4" PTC	No	No	-



VALVES & ACCESSORIES

Note: Photos represent a valve of the manufacturer and model for this section. The actual part number may also contain brackets and/or linkage. See photo section starting at page 112 for pictures of each individual part number

HEIGHT CONTROL VALVES

Part Number Chart - Remove Air To Dump Valves

Suspension

Remove Air To Dump									
Hadley									
	MERITOR NO.	OEM REF	MANUFACTURER MODEL/PART NO.	ARM LENGTH	APPLICATION	FITTINGS	BRACKET INCLUDED	LINKAGE INCLUDED	VALVE ONLY MERITOR NO.
	A-7806-Z-1014	-	500 Series	6 1/4"	Meritor RFS	1/4" NPT	No	No	-
	KIT11206	-	500 Series	6 1/4"	Meritor RFS	1/4" NPT	No	Yes	KIT11206
	R3011293	-	500 Series/ H00500CA	7", 8", 9"	Various	1/4" NPT	Yes	No	N/A
	KIT11308	-	Next Gen/ H01502KB	9"	Meritor RHP11 and RHP55	3/8" PTC	No	Yes	N/A
	KIT11332	-	Next Gen/ H01502KC	9"	Meritor RideSentury MPA	3/8" PTC	No	Yes	N/A
	R3014730	Various	Next Gen/ H01502UNC	7", 8", 9"	Universal	3/8" PTC	No	No	-

N/A - Not Available

Cab Suspensions					
Hadley					
	MERITOR NO.	MANUFACTURER MODEL/PART NO.	ARM LENGTH	FITTING	VALVE ONLY MERITOR NO.
	R3011464	600 Series / H00600P	2 1/4", 4"	1/8" NPT	-

Note: Photos represent a valve of the manufacturer and model for this section. The actual part number may also contain brackets and/or linkage. See photo section starting at page 112 for pictures of each individual part number

HEIGHT CONTROL VALVES

Barksdale Height Control Valves - By Dump Style

VALVES & ACCESSORIES

Height Control Valve, No Dump



MERITOR NO.	OEM REF	BARKSDALE SERIES	FITTINGS / PORT SIZES	ARM LENGTH	APPLICATION	LOCATION
R3013995	59935-002	55521	PTC	7"	Hendrickson AIRTEK® w/ STEERTEK Axle for Freightliner and Western Star	Right Hand
R3017088	59935-013	55521-Q150				Left Hand

Barksdale Valve, No Dump



MERITOR NO.	OEM REF	BARKSDALE SERIES	FITTINGS / PORT SIZES	ARM LENGTH	APPLICATION	LOCATION
R3017089	59935-024	5521-Q183	PTC	7"	Hendrickson AIRTEK® w/ STEERTEK NXT Axle for Freightliner and Western Star	Right Hand
R3017088	59935-013	55521-Q150				Left Hand Set Back
S.O.S.	59935-023	-				Left Hand Set Forward

Barksdale Valve, No Dump



MERITOR NO.	OEM REF	BARKSDALE SERIES	FITTINGS / PORT SIZES	ARM LENGTH	APPLICATION	LOCATION
R3013996	59935-011	55521	PTC	6"	Hendrickson AIRTEK® FOR INTERNATIONAL IC Buses	Right Hand
S.O.S.	59935-018					Left Hand

PTC = Push To Connect

HEIGHT CONTROL VALVES

Barksdale Height Control Valves - By Dump Style

Suspension

Barksdale Valve, No Dump					
					
MERITOR NO.	OEM REF	BARKSDALE SERIES	FITTINGS / PORT SIZES	ARM LENGTH	APPLICATION
R3015151	59935-003	55521	PTC	5 3/4"	HENDRICKSON AIRTEK® FOR MACK VEHICLES Built prior to 3/05

Barksdale Valve, No Dump With Bracket					
					
MERITOR NO.	OEM REF	BARKSDALE SERIES	FITTINGS / PORT SIZES	ARM LENGTH	APPLICATION
R3011494	60826-000	52321	1/4" NPT	5", 6 7/8", & 7 1/2"	Hendrickson HA360, 400, 460 Air Ride

Barksdale Valve, No Dump With Bracket					
					
MERITOR NO.	OEM REF	BARKSDALE SERIES	FITTINGS / PORT SIZES	ARM LENGTH	APPLICATION
R3011855	VS-227	52321	1/4" NPT	5" & 7 3/8" & 8 1/2"	Hendrickson INTRAAX AND VANTRAAX

Barksdale Valve, No Dump With Linkage					
					
MERITOR NO.	OEM REF	BARKSDALE SERIES	FITTINGS / PORT SIZES	ARM LENGTH	APPLICATION
R3015130	60961-155	55521	PTC	5 3/4"	Hendrickson AIRTEK® FOR INTERNATIONAL Dual HCV Conversion. Before 8/09

PTC = Push To Connect

HEIGHT CONTROL VALVES

Barksdale Height Control Valves - By Dump Style

Barksdale Valve, No Dump With Bracket & Linkage



Includes R3015151 Valve

MERITOR NO.	OEM REF	BARKSDALE SERIES	FITTINGS / PORT SIZES	ARM LENGTH	APPLICATION
R3014013	64089-000	55521	PTC	5 3/4"	HENDRICKSON AIRTEK® FOR MACK VEHICLES. Prior to 3/05 w/ 12 & 12.5K Axles

Barksdale Valve, No Dump With Bracket & Linkage



Includes R3015151 Valve

MERITOR NO.	OEM REF	BARKSDALE SERIES	FITTINGS / PORT SIZES	ARM LENGTH	APPLICATION
R3014014	64094-000	55521	PTC	5 3/4"	HENDRICKSON AIRTEK® FOR MACK VEHICLES. Prior to 3/05 w/ 13.2 & 14.6K Axles

VALVES & ACCESSORIES

PTC = Push To Connect

HEIGHT CONTROL VALVES

Barksdale Height Control Valves - By Dump Style

Suspension

Barksdale Valve, Apply Air to Dump



MERITOR NO.	OEM REF	BARSDALE SERIES	FITTINGS / PORT SIZES	ARM LENGTH	APPLICATION
R3016407	60501-000	52341	1/4" NPT	7"	HENDRICKSON PARASTEER/ BlueBird

Barksdale Valve, Apply Air to Dump With Bracket



Includes R3016407 Valve

MERITOR NO.	OEM REF	BARSDALE MODEL	FITTINGS / PORT SIZES	ARM LENGTH	APPLICATION
R3011870	57977-000	52341	1/4" NPT	7"	Hendrickson AR2

Barksdale Valve, Apply Air to Dump With Linkage



MERITOR NO.	OEM REF	BARSDALE SERIES	FITTINGS / PORT SIZES	ARM LENGTH	APPLICATION
R3016417	66277-001	52341	3/8" PTC	5 3/4"	Hendrickson Airtek for Spartan Motorhome Chassis With Drum Brakes, Left Hand

Barksdale Valve, Apply Air to Dump With Linkage



MERITOR NO.	OEM REF	BARSDALE SERIES	FITTINGS / PORT SIZES	ARM LENGTH	APPLICATION
R3016418	66277-002	52341	3/8" PTC	5 3/4"	Hendrickson Airtek for Spartan Motorhome Chassis With Drum Brakes, Right Hand

PTC = Push To Connect

HEIGHT CONTROL VALVES

Hadley Height Control Valves - By Dump Style

VALVES & ACCESSORIES

Hadley Valve, No Dump With Bracket



MERITOR NO.	HADLEY MODEL	FITTINGS / PORT SIZES	ARM LENGTH	APPLICATION
R309623	450 Series	1/4" Compression	7"	Various

Hadley Valve, No Dump With Bracket & Linkage



MERITOR NO.	OEM REF	HADLEY MODEL	FITTINGS / PORT SIZES	ARM LENGTH	APPLICATION
R3015271	23329-01	450 Series	1/4" Compression	7"	Reyco

Hadley Control Valve, No Dump

UNIVERSAL



MERITOR NO.	OEM REF	HADLEY MODEL	FITTINGS / PORT SIZES	ARM LENGTH	APPLICATION
A-7806-L-1052	-	Next Gen	3/8" PTC	5 1/2"	MTA Top Mount
R3014729	H01500UN	Next Gen	3/8" PTC	7", 8", and 9"	Universal

Hadley Valve, No Dump With Linkage

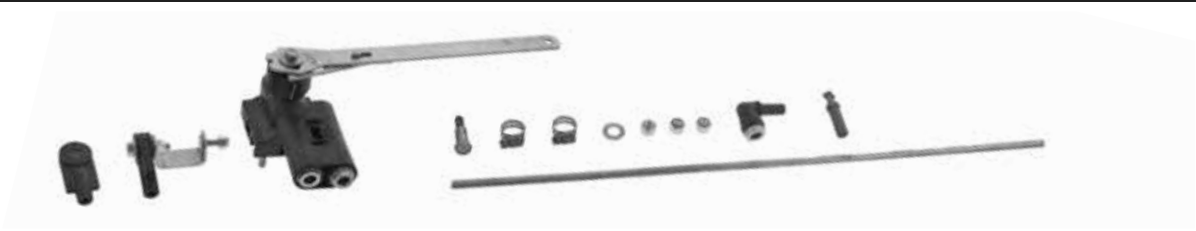

MERITOR NO.	HADLEY MODEL	FITTINGS / PORT SIZES	ARM LENGTH	APPLICATION
KIT11309	Next Gen	3/8" PTC	9"	Meritor RHP

PTC = Push To Connect

HEIGHT CONTROL VALVES

Hadley Height Control Valves - By Dump Style

Suspension

Hadley Valve, No Dump With Linkage



MERITOR NO.	HADLEY MODEL	FITTINGS / PORT SIZES	ARM LENGTH	APPLICATION
KIT11333	Next Gen	3/8" PTC	9"	Meritor RideSentury MPA

VALVES &
ACCESSORIES

PTC = Push To Connect

U.S. 888-725-9355
Canada 800-387-3889

MeritorPartsXpress.com
PB-9968-CMP (12-19)

HEIGHT CONTROL VALVES

Hadley Height Control Valves - By Dump Style

VALVES & ACCESSORIES

Hadley Valve, Apply Air to Dump



MERITOR NO.	HADLEY MODEL	FITTINGS / PORT SIZES	ARM LENGTH	APPLICATION
A-7806-Y-1013	500 Series	1/4" NPT	6 1/4"	Meritor RFS

Hadley Valve, Apply Air to Dump With Bracket



MERITOR NO.	HADLEY MODEL	FITTINGS / PORT SIZES	ARM LENGTH	APPLICATION
R309624	500 Series	1/4" NPT	3", 5", 7"	Hadley H00500C / Meritor M311501

Hadley Valve, Apply Air to Dump With Bracket

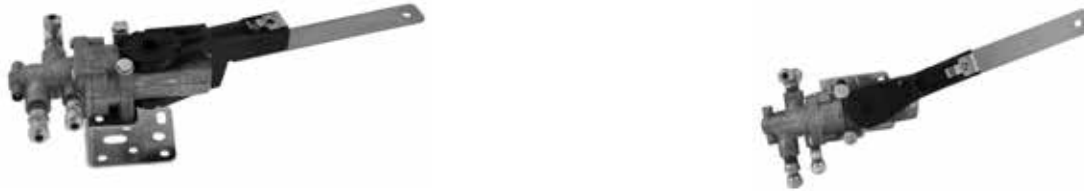

MERITOR NO.	HADLEY MODEL	FITTINGS / PORT SIZES	ARM LENGTH
R3011465	500 Series	1/4" Compression	9"

Hadley Valve, Apply Air to Dump With Linkage



Includes R3014352 Valve

MERITOR NO.	HADLEY MODEL	FITTINGS / PORT SIZES	ARM LENGTH	APPLICATION
KIT11207	500 Series	1/4" NPT	6 1/4"	Meritor RFS

PTC = Push To Connect

HEIGHT CONTROL VALVES

Hadley Height Control Valves - By Dump Style

Suspension

Hadley Valve, Apply Air to Dump

UNIVERSAL



MERITOR NO.	OEM REF	HADLEY MODEL	FITTINGS / PORT SIZES	ARM LENGTH	APPLICATION
R3014732	H01501PUD	Next Gen	1/4" PTC	7", 8", and 9"	Common On Peterbilt Prior To 2012
R3014731	H01501UD		3/8" PTC		-
A-7806-M-1053	-		3/8" PTC	5 1/2"	MTA Top Mount

VALVES &
ACCESSORIES

PTC = Push To Connect

U.S. 888-725-9355
Canada 800-387-3889

MeritorPartsXpress.com
PB-9968-CMP (12-19)

HEIGHT CONTROL VALVES

Hadley Height Control Valves - By Dump Style

VALVES & ACCESSORIES

Hadley Valve, Remove Air to Dump



MERITOR NO.	HADLEY MODEL	FITTINGS / PORT SIZES	ARM LENGTH	APPLICATION
A-7806-Z-1014	500 Series	1/4" NPT	6 1/4"	Meritor RFS

Hadley Valve, Remove Air to Dump With Bracket



MERITOR NO.	HADLEY MODEL	FITTINGS / PORT SIZES	ARM LENGTH	APPLICATION
R3011293	500 Series	1/4" NPT	7", 8", 9"	Various

Hadley Valve, Remove Air to Dump With Linkage



Includes R3014351 Valve

MERITOR NO.	HADLEY MODEL	FITTINGS / PORT SIZES	ARM LENGTH	APPLICATION
KIT11206	500 Series	1/4" NPT	6 1/4"	Meritor RFS

Hadley Valve, Remove Air to Dump

UNIVERSAL



MERITOR NO.	OEM REF	HADLEY MODEL	FITTINGS / PORT SIZES	ARM LENGTH	APPLICATION
R3014730	H01501UD	Next Gen	PTC	7", 8", and 9"	Universal

HEIGHT CONTROL VALVES

Hadley Height Control Valves - By Dump Style

Hadley Valve, Remove Air to Dump With Linkage				
				
MERITOR NO.	HADLEY MODEL	FITTINGS / PORT SIZES	ARM LENGTH	APPLICATION
KIT11308	Next Gen	3/8" PTC	9"	Meritor RHP11 and RHP55

Hadley Valve, Remove Air to Dump With Linkage				
				
MERITOR NO.	HADLEY MODEL	FITTINGS / PORT SIZES	ARM LENGTH	APPLICATION
KIT11332	Next Gen	3/8" PTC	9"	Meritor RideSentury MPA

Hadley Valve, Cab Suspension					
					
MERITOR NO.	HADLEY MODEL	FITTINGS / PORT SIZES	ARM LENGTH	VALVE ONLY MERITOR NO.	APPLICATION
R3011464	600 Series /H00600P	1/8" NPT	2 1/4", 4"	R3011464	Cab Suspensions

VALVES & ACCESSORIES

PTC = Push To Connect

U.S. 888-725-9355
Canada 800-387-3889

MeritorPartsXpress.com
PB-9968-CMP (12-19)

HEIGHT CONTROL VALVES

Haldex Height Control Valves - By Dump Style

Haldex Valve, No Dump With Bracket & Linkage

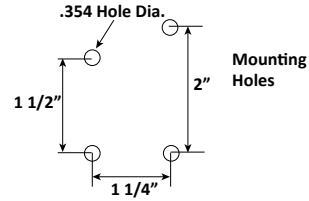
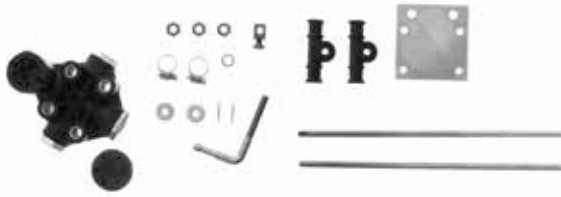

MERITOR NO.	OEM REF	HALDEX MODEL	FITTINGS / PORT SIZES	MOUNTING	ARM LENGTH	APPLICATION
R3013922	90555105, 90554241	IR Series	1/4" NPT	See Above	Adjustable	Neway

Haldex Valve, No Dump With Bracket



MERITOR NO.	OEM REF	HALDEX MODEL	FITTINGS / PORT SIZES	ARM LENGTH	APPLICATION
R304323	90054007	CR Series	1/8" NPT	7"	Neway

Haldex Valve, No Dump



MERITOR NO.	OEM REF	HALDEX MODEL	FITTINGS / PORT SIZES	ARM LENGTH	APPLICATION
R3013917	90554945	PR Plus Series	1/4" NPT	7"	Neway

Haldex Valve, No Dump



MERITOR NO.	OEM REF	HALDEX MODEL	FITTINGS / PORT SIZES	ARM LENGTH	APPLICATION
R3013919	90555085	PR Plus Series	M12 x 1.5	7"	Neway

VALVES & ACCESSORIES

HEIGHT CONTROL VALVES

Haldex Height Control Valves - By Dump Style

Suspension

Haldex Valve, No Dump



MERITOR NO.	OEM REF	HALDEX MODEL	FITTINGS / PORT SIZES	ARM LENGTH	APPLICATION
R3013920	90555273	PR Plus Series	3/8" PTC	7"	Neway

VALVES &
ACCESSORIES

HEIGHT CONTROL VALVES

Haldex Height Control Valves - By Dump Style

Haldex Valve, Apply Air to Dump

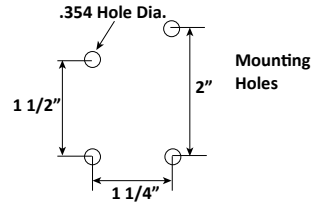

MERITOR NO.	OEM REF	HALDEX MODEL	FITTINGS / PORT SIZES	MOUNTING	ARM LENGTH	APPLICATION
R3013916	90555106	IR Series	1/4" NPT	See Above	Adjustable	Neway

Haldex Valve, Apply Air to Dump



MERITOR NO.	OEM REF	HALDEX MODEL	FITTINGS / PORT SIZES	ARM LENGTH	APPLICATION
R3013918	90554950	PR Plus Series	3/8" PTC, Pilot 1/4" PTC	7"	Neway

Haldex Valve, Apply Air to Dump



MERITOR NO.	OEM REF	HALDEX MODEL	FITTINGS / PORT SIZES	ARM LENGTH	APPLICATION
R3013921	90555274	PR Plus Series	3/8" PTC, Pilot 1/4" PTC	7"	Neway

VALVES & ACCESSORIES

HEIGHT CONTROL VALVES

Suspension

Neway / Ridewell - By Dump Style

Neway, No Dump					
					
MERITOR NO.	OEM REF	NEWAY MODEL	FITTING / PORT SIZES	ARM LENGTH	APPLICATION
R3016586	50860013	Max Valve	PTC	5 1/2", 7", 8", & 9"	No Dump

Neway, Apply To Dump					
					
MERITOR NO.	OEM REF	NEWAY MODEL	FITTING / PORT SIZES	ARM LENGTH	APPLICATION
R3016580	50860014	Max Valve	PTC	5 1/2", 7", 8", & 9"	Apply Air To Dump

Neway, Remove Air To Dump					
					
MERITOR NO.	OEM REF	NEWAY MODEL	FITTING / PORT SIZES	ARM LENGTH	APPLICATION
R3016571	50860016	Max Valve	PTC	5 1/2", 7", 8", & 9"	Remove Air to Dump

Ridewell, No Dump					
					
MERITOR NO.	OEM REF	RIDEWELL MODEL	FITTINGS / PORT SIZES	ARM LENGTH	APPLICATION
R3012525	Ridewell 124723B205, 124723B204	Extreme Air w/o Dump	PTC	9"	Ridewell

VALVES & ACCESSORIES

HEIGHT CONTROL VALVES

Linkage And Kits

VALVES & ACCESSORIES

Linkage and Linkage Kits

FOR MODELS:
Neway
AD & ARD



MERITOR NO.	GENUINE	OEM REF
R3016623		Neway 48100267/SRK-205

Linkage Half

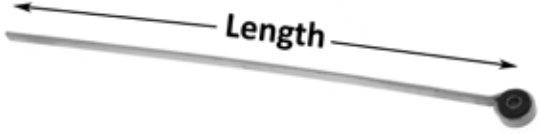

MERITOR NO.	OEM REF	LENGTH	OD
R304334	Neway 90054460	14"	1/4"

Linkage Kits



MERITOR NO.	OEM REF	NOTES
R307852	Replaces Neway SRK-168, Peterbilt03-06224	Universal Adjustable

Link Half

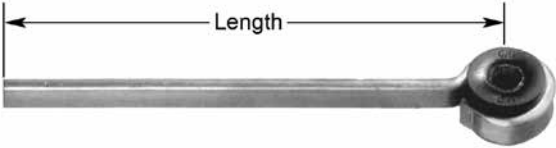

MERITOR NO.	OEM REF	A	OD
R304333	Neway 90054188	8"	1/4"

Linkage Kit



MERITOR NO.	OEM REF	NOTES
R303760A	Hendrickson 58994-021	Adjustable

Hand Valve



MERITOR NO.	OEM REF
R304329	Neway 90054082

Linkage and Linkage Kits



MERITOR NO.	OEM REF	NOTES
R309625	Replaces Hadley HPB450-3	Universal Adjustable

Solenoid Valve



MERITOR NO.	OEM REF	NOTES
R304331	Neway 90054075	Normally Open

Other Air Valves & Accessories

Solenoid Valve		
		
MERITOR NO.	OEM REF	NOTES
R304325	Neway 90054074	Normally Closed

Manual Valve	
	
MERITOR NO.	OEM REF
R304326	Neway 90054088

Quick Release Valve	
	
MERITOR NO.	OEM REF
R304330A	Neway 90054096

Pressure Regulator Valve	
	
MERITOR NO.	OEM REF
R304327	Neway 90054077

Brake Protection Valve		
		
MERITOR NO.	OEM REF	NOTES
R304324	Neway 90554107/90054001	Includes Internal Filter

Pressure Protection Valve	
	
MERITOR NO.	OEM REF
R303762	Hendrickson 30272-000

Pilot Valve	
	
MERITOR NO.	OEM REF
R304328	Neway 90054079

Air Gauge	
	
MERITOR NO.	OEM REF
R304332	Neway 90054280

VALVES & ACCESSORIES

HEIGHT CONTROL VALVE AND ACCESSORIES

CROSS REFERENCE

REPLACES OE NUMBER	OEM	MERITOR PART NO.
52341-Q123	Barksdale	R3016407
52341-Q123	Barksdale	R3011870
52341-Q211-320136	Barksdale	R3016417
52341-Q212-320136	Barksdale	R3016418
55521-Q115	Barksdale	R3013995
55521-Q116	Barksdale	R3015151
55521-Q116-32071	Barksdale	R3014013
55521-Q141-320110	Barksdale	R3015130
55521-Q150	Barksdale	R3017088
55521-Q160	Barksdale	R3013996
55521-Q183	Barksdale	R3017089
KD2256	Barksdale	R3011494
H00450CE	Hadley	R309623
H00500C	Hadley	R309624
H00500CA	Hadley	R3011293
H00500CB	Hadley	R3011465
H00500DB	Hadley	R3014352
H00600P	Hadley	R3011464
H01500UN	Hadley	R3014729
H01501UD	Hadley	R3014732
H01502KB	Hadley	R3013907
H01502KC	Hadley	R3014333
H01502UNC	Hadley	R3014730
H0150PUD	Hadley	R3014731
HPB450-3	Hadley	R309625
30272-000	Hendrickson	R303762
59427-006	Hendrickson	R3014013
59427-013A	Hendrickson	R3015130
59935-002	Hendrickson	R3013995
59935-003	Hendrickson	R3015151
59935-011	Hendrickson	R3013996
59935-013	Hendrickson	R3017088
59935-024	Hendrickson	R3017089
60501-000	Hendrickson	R3016407
60501-000	Hendrickson	R3011870
60826-000	Hendrickson	R3011494
64094-000	Hendrickson	R3014014
66277-001	Hendrickson	R3016417
66277-002	Hendrickson	R3016418
VS-227	Hendrickson	R3011855
58994-021	Hendrickson	R303760A

REPLACES OE NUMBER	OEM	MERITOR PART NO.
48100267	Neway	R3016623
90054001	Neway	R304324
90054007	Neway	R304323
90054074	Neway	R304325
90054075	Neway	R304331
90054077	Neway	R304327
90054079	Neway	R304328
90054082	Neway	R304329
90054088	Neway	R304326
90054096	Neway	R304330A
90054188	Neway	R304333
90054280	Neway	R304332
90054460	Neway	R304334
90554107	Neway	R304324
90554241	Neway	R3013922
90554945	Neway	R3013917
90554950	Neway	R3013918
90555085	Neway	R3013919
90555105	Neway	R3013922
90555106	Neway	R3013916
90555273	Neway	R3013920
90555274	Neway	R3013921
SRK-168	Neway	R307852
SRK-205	Neway	R3016623
03-06224	Peterbilt	R307852
23329-01	Reyco	R3015271

NUMERICAL LISTING

Suspension

PART NO.	PAGE NO.
15-X-1933	42
1227-R-1604	44
1229-M-4979	45
A1-3133-Y-8345	67
A-3133-G-8249	74
A-7806-L-1052	108, 116
A-7806-M-1053	109, 119
A-7806-Y-1013	109, 118
A-7806-Z-1014	111, 120
G-640	88
G-927	92
G-934	86
G-1020	92
G-1160	92
G-1332	90
G-1964	92
G-1966	88
G-1980	70, 86
G-1982	92
G-1999A	86
G-2514	60, 72
G-2515	64
G-2781	48, 51
G-2781A	48, 51
G-2830	51
G-2844	48, 54
G-2845	48, 54
G-2850	88
G-2889	48, 52
G-2899	61, 73
G-2939	87
G-3277	58, 66
G-3390	58, 66, 69
G-3530	95
G-3531	95
G-3532	97
G-3534	87, 99
G-3546	60, 71
G-3784	87
G-3817	86
G-3844	48, 56
G-3917	48, 50
G-3977	88
G-4252	89
G-4254	88
G-4255	87
G-4256	87
G-4410A	87
G-4669	88
G-4677A	89
G-4678A	89
G-4753	60, 75
G-4771	61, 75
G-4775	90
G-4813	48, 54
G-4824	63

PART NO.	PAGE NO.
G-4825	76
G-4827	87
G-5082	60, 75
G-5083	60, 75
G-5216	90
G-7532	48, 51
G-7621	87
G-7700	48, 50
G-7713	88
G-7766	89
G-7767	89
G-7841	90
G-7853	62, 75
G-7887	60, 75
G-8796	94
G-8797	87, 98
G-8799	88, 99
G-8800	97
G-8804	91
G-8941	60, 71
G-9292	87
G-9293	89
G-9305	48, 50
G-9307	61, 70
G-9324	91
G-9366	48, 50
G-9471	48, 52
G-9570	48, 51
G-9874	91
G-10057	92
G-10250	48, 54
G-10303	91
G-15536	61, 71
G-15537	93, 99
G-15538	87, 99
G-15541	91
G-15543	93, 99
G-15597	94
G-15600	91
G-15613	93, 99
G-15614	96
G-15619	97
G-15620	96
G-15640	96
G-15644	94
G-15645	95
G-15646	95
G-15648	97
G-15655	94
G-15661	95
G-15662	95
G-15663	96
G-15666	95
G-15667	88, 99
G-15671	91
G-16094	91

PART NO.	PAGE NO.
G-16098	61, 75
G-16099	62, 75
G-16107	89
G-16108	23, 89
G-16118	62, 75
G-16141	87, 98
G-16157	88, 99
G-16158	88, 99
G-16163	93, 99
G-16167	87, 98
G-16236	86
G-16292	93, 99
G-16305	94
G-16319	95
G-16321	96
G-16641	45
G-16642	46
G-16653	62, 71
G-16703	96
KIT11206	111, 120
KIT11207	109, 118
KIT11308	111, 121
KIT11309	116, 108
KIT11332	111, 121
KIT11333	108, 117
M301501	41
M301502	41
M301530	45
R30TR5050-08	30
R30TR5050-10	30
R30TR5050-12	30
R30TR5050-14	30
R30TR5050-16	30
R30TR5050-18	30
R30TR5050-20	30
R30TR5050-22	30
R30TR5050-24	30
R30TR5050-26	30
R30TR5050-28	30
R30TR5050-30	30
R30TR5050-32	30
R30TR5050-34	30
R30TR5050-36	30
R30TR5056-10	30
R30TR5056-12	30
R30TR5056-14	30
R30TR5056-16	30
R30TR5056-18	30
R30TR5056-20	30
R30TR5056-22	30
R30TR5056-24	30
R30TR5056-26	30
R30TR5056-28	30
R30TR5056-30	30
R30TR5056-32	30
R30TR5056-34	30

NUMERICAL LISTING

NUMERICAL LISTING

PART NO.	PAGE NO.
R30TR5056-36	30
R30TR5056-38	30
R30TR5056-40	30
R30TR5056-42	30
R30TR8062-12	31
R30TR8062-14	31
R30TR8062-16	31
R30TR8062-18	31
R30TR8062-20	31
R30TR8062-22	31
R30TR8062-24	31
R30TR8062-26	31
R30TR8062-28	31
R30TR8062-30	31
R30TR8062-32	31
R30TR8062-34	31
R30TR8062-36	31
R30TR8062-38	31
R30TR8062-40	31
R30TR8062-42	31
R30TR8062-44	31
R30TR8062-46	31
R30TR8062-48	31
R30TR8075-12	31
R30TR8075-14	31
R30TR8075-16	31
R30TR8075-18	31
R30TR8075-20	31
R30TR8075-22	31
R30TR8075-24	31
R30TR8075-26	31
R30TR8075-28	31
R30TR8075-30	31
R30TR8075-32	31
R30TR8075-34	31
R30TR8075-36	31
R30TR8075-38	31
R30TR8075-40	31
R30TR8075-42	31
R30TR8075-44	31
R30TR8075-46	31
R30TR8075-48	31
R30TR8075-50	31
R30TR8075-52	31
R30TR8087-18	31
R30TR8087-20	31
R30TR8087-22	31
R30TR8087-24	31
R30TR8087-26	31
R30TR8087-28	31
R30TR8087-30	31
R30TR8087-32	31
R30TR8087-34	31
R30TR8087-36	31
R30TR8087-38	31
R30TR8087-40	31

PART NO.	PAGE NO.
R30TR8087-42	31
R30TR8087-44	31
R30TR8087-46	31
R30TR8087-48	31
R30TR8087-50	31
R30TR8087-52	31
R30TR8100-16	31
R30TR8100-20	31
R30TR8100-24	31
R30TR8100-28	31
R30TR8100-32	31
R30TR8100-36	31
R30TR8100-40	31
R30TR8100-44	31
R30TR8100-48	31
R30TR8112-30	31
R30TR8112-32	31
R30TR8112-34	31
R30TR8112-36	31
R30TR8112-38	31
R30TR8125-30	31
R30TR8125-32	31
R30TR8125-34	31
R30TR8125-36	31
R30TR8125-38	31
R30U5161-12	34
R30U5161-13	34
R30U5161-14	34
R30U5161-15	34
R30U5161-16	34
R30U5161-18	34
R30U5161-22	34
R30U5163-14	34
R30U5163-18	34
R30U5165-12	34
R30U5165-14	34
R30U5165-15	34
R30U5165-16	34
R30U5165-18	34
R30U5243-16	36
R30U5243-18	36
R30U5243-20	36
R30U5244-16	36
R30U5244-18	36
R30U5244-20	36
R30U5261-18	36
R30U5263-14	36
R30U5263-18	36
R30U8142-06	32
R30U8142-074	32
R30U8143-074	32
R30U8145-076	32
R30U8151-10	32
R30U8151-12	32
R30U8151-14	32
R30U8151-16	32

PART NO.	PAGE NO.
R30U8151-18	32
R30U8151-22	32
R30U8153-10	32
R30U8153-12	32
R30U8153-14	32
R30U8153-18	32
R30U8154-10	32
R30U8154-12	32
R30U8154-18	32
R30U8155-12	32
R30U8155-14	32
R30U8155-16	32
R30U8155-073	32
R30U8156-08	32
R30U8157-08	32
R30U8161-10	32
R30U8161-11	32
R30U8161-12	32
R30U8161-13	32
R30U8161-14	32
R30U8161-15	32
R30U8161-15S1	32
R30U8161-16	32
R30U8161-17	32
R30U8161-18	32
R30U8161-18S1	33
R30U8161-20	33
R30U8161-22	33
R30U8161-122	32
R30U8162-18	33
R30U8162-22	33
R30U8163-14	33
R30U8163-16	33
R30U8164-10	33
R30U8164-12	33
R30U8164-16	33
R30U8164-18	33
R30U8165-10	33
R30U8165-12	33
R30U8165-13	33
R30U8165-14	33
R30U8165-16	33
R30U8165-18	33
R30U8165-076	33
R30U8166-12	33
R30U8168-082	33
R30U8168-082H	33
R30U8169-156	33
R30U8169-166	33
R30U8175-104	33
R30U8176-114	33
R30U8177-114	33
R30U8178-126	33
R30U8179-09	33
R30U8186-154	33
R30U8187-154	33

NUMERICAL LISTING

Suspension

PART NO.	PAGE NO.
R30U8187-164	33
R30U8253-05	35
R30U8253-12	35
R30U8254-10	35
R30U8254-12	35
R30U8254-14	35
R30U8255-05	35
R30U8256-077	35
R30U8257-11	35
R30U8257-12	35
R30U8257-087	35
R30U8261-18	35
R30U8263-14	35
R30U8264-10	35
R30U8264-12	35
R30U8264-14	35
R30U8264-16	35
R30U8264-083	35
R30U8265-16	35
R30U8265-084	35
R30U8267-153	35
R30U8268-105	35
R30U8268-134	35
R30U8271-104	35
R30U8271-111	35
R30U8286-134	35
R30U8286-154	35
R30U8287-11	35
R30U8287-14	35
R30U8294-18	35
R30U8294-162	35
R30U8294-184S	35
R30U8351-18	37
R30U8353-10	37
R30U8353-12	37
R30U8353-15	37
R30U8354-10	37
R30U8354-12	37
R30U8354-12P	37
R30U8362-19F	37
R30U8363-15N	37
R30U8375-14	37
R30U8375-154	37
R30U8394-18	37
R30U8394-144	37
R30U8394-162S	37
R30U8394-172S	37
R30U8394-192S	37
R30U8396-165S	37
R30U8466-073H	38
R30U8466-082H	38
R30U8475-114	38
R30U8479-090	38
R30U8479-104	38
R30U8479-124A	38
R30U8554-033	38

PART NO.	PAGE NO.
R30U8575-126	38
R30U8578-094	38
R30U8578-124A	38
R30U8585-132	38
R30U8673-154	37, 38
R30640	88
R30700	27
R30702A	27
R30813	22, 92
R30900	40
R30901	40
R30905	45
R30907	45
R30927	22, 92
R30934	22, 86
R30937	43
R301020	22, 92
R301021	45
R301023	22
R301024	22
R301038	92
R301061	86
R301072	22, 88
R301073	42
R301074	45
R301107	43
R301159	22, 92
R301160	22, 92
R301166	40
R301204	40
R301206	45
R301312A	22
R301330	22
R301331	22
R301332	22, 90
R301333	22, 90
R301334	22
R301335	89
R301336	88
R301338	93
R301339	22, 93
R301340	89
R301341A	22, 89
R301351	87
R301352	87
R301354	43
R301545	89
R301552	90
R301594	93
R301595	93
R301600	25
R301817	94
R301818	94
R301820	41
R301828	44
R301834	45

PART NO.	PAGE NO.
R301835	44
R301855	42
R301856	42
R301859	42
R301860	42
R301876	87, 98
R301940	22, 89
R301943	44
R301946	44
R301960	22
R301963	22
R301964	22, 92
R301966	88
R301969	46
R301972	40
R301980	22, 70, 86
R301981	22
R301982	22, 92
R301984	92
R301986A	45
R301987	40
R301997	40, 42
R301999A	22, 86
R302002	43
R302003	22
R302009	22
R302010	22
R302017	44, 83
R302018	46, 83
R302021	46
R302022	40
R302035	43
R302079	44, 83
R302130	25
R302225	22, 91
R302226	22, 91
R302227	92
R302228	22, 93
R302232	22
R302238	87
R302273	87
R302274	40
R302275	45
R302292	58, 67, 68
R302293	58, 67
R302294	58, 64
R302295	58, 64
R302510	58, 67
R302511	58, 67
R302512	58, 64, 65
R302513	58, 64, 65, 68
R302514	60, 72
R302515	58, 64
R302545	45
R302546	45
R302547	45

NUMERICAL LISTING

NUMERICAL LISTING

PART NO.	PAGE NO.
R302548	46
R302553	93
R302554	89
R302556	94
R302570	42
R302573	45
R302644	25
R302771	89
R302781	48, 51
R302781A	22, 48, 51
R302814	91
R302815	22, 93
R302816	87
R302830	48, 51
R302831	48, 51
R302832	46
R302833	46
R302843	48, 54
R302844	48, 54
R302845	48, 54
R302846A	49, 54
R302849	88
R302850	88
R302852	40
R302853	46
R302854	44
R302855	60, 76
R302856	60, 76
R302858	61, 76
R302860	61, 76
R302866A	59, 68
R302889	48, 52
R302890	48, 52
R302891	40
R302892	43
R302899	61, 73
R302916	93
R302917	22
R302919	22
R302920	22
R302921A	22, 89
R302922A	22
R302922A	89
R302923A	89
R302924A	22, 89
R302925	90
R302934	46
R302935	22, 90
R302938	88
R302939	22, 75, 87
R302940	22, 88
R302943	23
R302945	23
R302947A	23
R302951	40
R302956	46

PART NO.	PAGE NO.
R302957	46
R302958	46
R302959	46
R302960	45
R302975	45
R302981	40
R302983	44
R302988	44
R302989	40
R303000	44
R303001	44
R303002A	44
R303003	44
R303004	44
R303005	44
R303006	44
R303012	48, 50
R303079	23
R303080	48, 50
R303081	48, 50
R303082	88
R303086	86
R303165	78
R303166	78
R303167	78
R303168	78
R303169	78
R303170	78
R303171	78
R303172	78
R303173	78
R303174	79
R303175	79, 80
R303176	79
R303177A	79
R303178	79
R303179A	79
R303180	79
R303181	80
R303182	80
R303183A	80
R303184	80
R303185	78
R303186	80
R303188	39
R303189	39
R303190	39
R303191	39
R303192	39
R303193	39
R303194	39
R303195	39
R303196	39
R303197	39
R303198	39
R303199A	39

PART NO.	PAGE NO.
R303224	40
R303240	40
R303276	58, 66
R303277	58, 66
R303283A	58, 68
R303284A	58, 68
R303296	92
R303297	46
R303298	44
R303359	86
R303362	86
R303383	48, 56
R303390	58, 66, 69
R303391	60, 77
R303394A	86
R303398	48, 56
R303411	91
R303415	40
R303530	95
R303531	95
R303533	87, 98
R303540A	90
R303541	46
R303542	40
R303543	45
R303546	60, 71
R303555	40
R303560	44
R303563	90
R303564	42
R303565	45
R303579	23, 90
R303582	23
R303690	42
R303691	40
R303692	42
R303693	42
R303696	40
R303699	46
R303715	96
R303717	97
R303731	60, 72
R303732	61, 72
R303760A	126
R303761	95
R303762	127
R303764	58, 68
R303773	60, 72
R303774A-2	60, 72
R303783	48, 53
R303784	87
R303785	42
R303788	60, 74
R303789	61, 74
R303792	41
R303793	43

NUMERICAL LISTING

Suspension

PART NO.	PAGE NO.
R303817	86
R303818	42
R303839	86
R303844	48, 56
R303849	86
R303868	91
R303900	88
R303976	23
R303977	23, 88
R303978	48, 54
R303987	78
R303988	79
R304252	89
R304253	23, 89
R304254	88
R304255	23, 87
R304256	87
R304257	23, 92
R304273	44
R304274	44
R304275	44
R304278	46
R304315	46
R304319	60, 75
R304323	108, 122
R304324	127
R304325	127
R304326	127
R304327	127
R304328	127
R304329	126
R304330A	127
R304331	126
R304332	127
R304333	126
R304334	126
R304345	41
R304347	44
R304348	40, 41
R304353	45
R304358	44
R304359	45
R304361	40, 42
R304363	45
R304364	40, 42
R304382A	23
R304403	23, 92
R304410A	23, 87
R304421	44
R304664	91
R304669	23, 88
R304677A	23, 89
R304678A	89
R304683	90
R304745	23, 90
R304752	88

PART NO.	PAGE NO.
R304753	60, 75
R304755	46
R304759	41
R304771	61, 75
R304775	23, 90
R304778	42
R304779	44
R304789	59, 63
R304790	59, 63
R304791	61, 70
R304792	61
R304792	70
R304796	58, 68
R304813	48, 54
R304824	58, 63, 68
R304825	61, 76
R304827	87
R304830	40
R304833	40
R304834A	23
R304836	40
R304961A	44
R305032	43
R305082	60, 75
R305083	60, 75
R305216	23, 90
R305219	46
R305227	23
R305245	49, 55
R305246	49, 56
R305255A	59, 68
R305256	62, 76
R305265	48, 51
R305269	87
R305270	86
R305271	42
R305272	41
R305273	46
R305275	74, 91
R305276	86
R305282	60, 72
R305283	61, 72
R305421	90
R305423	46
R305427	41
R305428	42
R305429	45
R305432	90
R305439	42
R306121	88
R306126	88
R306127	88
R306128	89
R306979	93
R306980	93
R307426	3, 23, 90

PART NO.	PAGE NO.
R307427	3, 23, 90
R307429	4
R307430	4
R307431	4
R307432	4, 22, 92
R307433	5, 7, 22, 92
R307434	5, 15
R307439	5
R307440	5
R307441	11, 22, 89
R307442	13, 22
R307443	8, 13, 22, 90
R307444	13, 23, 87
R307446A	10, 23, 88
R307447	3, 90
R307448	16
R307449	14
R307450	6, 27
R307451	6, 27
R307452	6, 22, 86
R307453	7, 22, 23, 86
R307455	7, 23, 90
R307457	8, 92
R307459	8
R307460	8
R307461	8
R307462	8, 16
R307463	8
R307465	9
R307466	9
R307467	9
R307468	9
R307469	9, 16
R307470	9
R307471	9
R307472	10, 16
R307473	9
R307474	10, 21, 90
R307475	10
R307477	11
R307478	11, 22, 89
R307479	11, 22, 89
R307480	11, 22
R307481	11, 22
R307482	11
R307483	12
R307484	12
R307485	12, 23, 87
R307486	14, 22, 90
R307487	14
R307488	14, 90
R307489	14, 90
R307491	14
R307492	14
R307493	14, 90
R307497	14

NUMERICAL LISTING

NUMERICAL LISTING

PART NO.	PAGE NO.
R307498	15
R307499	15, 90
R307500	15
R307502	15
R307503	15
R307504	15
R307505	16
R307506	15
R307507	16
R307508	17
R307509	16, 23, 90
R307510	17, 23, 90
R307515	17, 88
R307516	17, 88
R307517	17, 88
R307518	17
R307520	4, 18, 22, 86
R307522	18, 22, 92
R307523	18, 22, 92
R307524	19, 89
R307525	19
R307526	19
R307527	19
R307528	21, 23, 92
R307529	21, 23, 92
R307532	23, 48, 51
R307533	40
R307621	23, 87
R307638	21, 22, 91
R307639	21, 22, 91
R307640	10
R307641	11
R307643	12
R307644	12
R307645	17
R307683	58, 66
R307684	59, 66
R307685	59, 66
R307700	48, 50
R307701	90
R307703	41
R307709	49, 55
R307710	49, 55
R307713	88
R307741	58, 68
R307742	59, 68
R307743	59, 68
R307744	60, 76
R307746	62, 76
R307750	86
R307766	23, 89
R307767	23, 89
R307841	90
R307852	126
R307853	62, 75
R307857	40

PART NO.	PAGE NO.
R307869	48, 53
R307870	87
R307887	60, 75
R307918	6, 22, 48, 51
R308650	6
R308651	21, 22, 93
R308652	6, 27
R308653	17, 22, 92
R308654	18, 23, 88
R308655	11, 23, 92
R308656	20
R308663	5, 23, 90
R308664	5, 23
R308665	8, 23
R308666	7, 23, 87
R308667	11, 22
R308669	14
R308670	14, 22
R308671	14, 22
R308672	22, 90
R308672	13
R308673	12, 22
R308674	12, 22
R308676	14, 22, 87
R308677	13, 22, 88
R308678	12, 23
R308679	12, 23
R308680	12, 23
R308681	13, 23, 89
R308682	13, 23, 92
R308683	13, 23, 87
R308684	13, 23, 92
R308688	17, 22, 88
R308689	19, 22, 92
R308691	18, 22, 92
R308702	89
R308796	94
R308797	87, 98
R308799	88, 99
R308800	97
R308804	91
R308808	61
R308821	61, 74, 77
R308841	44
R308853	61, 77
R308909	41
R308910	41
R308911	43
R308917	3, 23, 90
R308918	4, 19
R308919	16
R308927	6, 27
R308931	48, 50
R308941	60, 71
R309286	86
R309287	91

PART NO.	PAGE NO.
R309288	91
R309292	87
R309293	89
R309305	48, 50
R309307	61, 70
R309321	23, 92
R309322	92
R309324	91
R309325	92
R309326	92
R309330	49, 53
R309350	23
R309359	93
R309361	5, 22
R309362	5, 22
R309368	88
R309376	41
R309394	60, 72
R309395	74
R309402	49, 51
R309407	61, 72
R309409	60, 72
R309419	89
R309430	42
R309439	88
R309440	91
R309450	45
R309452	45
R309454	45
R309457	87
R309458	90
R309471	48, 52
R309472	23
R309473	7, 23
R309474	6, 22
R309476	58, 65, 67
R309477	61, 73
R309478	23
R309479	7, 23
R309482	45
R309486	7, 23
R309489	49, 53
R309491	49, 53
R309492	49, 53
R309506	20, 87
R309507	20
R309510	21, 22, 93
R309512A	21, 22, 89
R309514	22
R309515	22, 89
R309518	21, 22, 93
R309521	90
R309545	18, 22
R309548	22
R309549	86
R309551	18, 23

NUMERICAL LISTING

Suspension

PART NO.	PAGE NO.
R309552	18, 22
R309555	17, 23
R309567	7, 23, 48, 51
R309570	48, 51
R309575	26
R309579	19, 23, 92
R309583	19, 23
R309584	58, 68
R309585	60, 76
R309586	49, 55
R309603	45
R309604	45
R309605	44
R309606	44
R309607	43
R309611	46
R309612	46
R309613	36
R309614	36
R309619	61, 76
R309620	59, 68
R309623	108, 116
R309624	109, 118
R309625	126
R309869	60, 71
R309874	91
R3010057	23, 92
R3010250	48, 54
R3010302	10, 23, 89
R3010303	91
R3010308	92
R3010309	93
R3010310	82, 84
R3010311	82, 84
R3010312	82, 84
R3010313	82, 84
R3010314	82, 84
R3010315	83, 84
R3010316	83, 84
R3010317	83, 84
R3010318	83, 84
R3010319	83, 84
R3010320	91
R3010321	93
R3010322	91
R3010678	91
R3010764	60, 74
R3010765	61, 74
R3010768A	48, 54
R3011293	111, 120
R3011448	59, 66
R3011452	48, 52
R3011464	111, 121
R3011465	109, 118
R3011494	107, 113
R3011748	82

PART NO.	PAGE NO.
R3011768	61
R3011769	59
R3011784	82
R3011820	85
R3011821	85
R3011853	4
R3011855	107, 113
R3011870	109, 115
R3012001	95
R3012525	125
R3013916	110, 124
R3013917	108, 122
R3013918	110, 124
R3013919	108, 122
R3013920	108, 123
R3013921	110, 124
R3013922	108, 122
R3013961	86
R3013962	93
R3013964	86
R3013965	93
R3013967	87
R3013969	93
R3013970	91
R3013971	91
R3013972	93
R3013974	26, 85
R3013992	88
R3013993	61, 72, 74
R3013995	107, 112
R3013996	107, 112
R3014013	107, 114
R3014014	107, 114
R3014026	91
R3014346	26
R3014398	93
R3014632	86
R3014634	26
R3014641	91
R3014642	91
R3014643	93
R3014644	91
R3014725	92
R3014727	83
R3014729	104, 108, 116
R3014730	104, 111, 120
R3014731	104, 109, 119
R3014732	109, 119
R3014773	59, 63
R3014774	59, 63
R3014818	49, 53
R3014925	49, 52
R3014969	59, 63
R3014975	59, 63
R3014976	59, 63
R3014977	62, 70

PART NO.	PAGE NO.
R3014978	61, 70
R3014979	61, 70
R3014985	60, 70
R3014986	62, 70
R3014987	59, 63
R3014989	59, 63
R3014990	61, 70
R3014991	61, 70
R3015094	44
R3015099	41
R3015101	41
R3015102	41
R3015106	45
R3015130	107, 113
R3015140	41
R3015151	107, 113
R3015160	41
R3015182	42
R3015184	43
R3015188	41
R3015189	41
R3015191	41
R3015192	42
R3015194	41
R3015195	41
R3015199	41
R3015206	41
R3015207	46
R3015240	41
R3015266	62, 76
R3015267	40
R3015271	108, 116
R3015276	62, 76
R3015286	42
R3015291	40
R3015293	62, 76
R3015294	59, 68
R3015295	49, 56
R3015312	40
R3015315	41
R3015331	49, 52
R3015338	49, 52
R3015342	59, 66
R3015343	59, 66
R3015344	59, 66
R3015346	59, 66
R3015348	49, 53
R3015350	59, 66
R3015353	59, 66
R3015377	49, 53
R3015378	49, 53
R3015379	49, 53
R3015412	46
R3015429	59, 67
R3015430	49, 53
R3015433	49, 53

NUMERICAL LISTING

NUMERICAL LISTING

PART NO.	PAGE NO.
R3015475	49, 53
R3015480	48, 52
R3015536	61, 71
R3015537	99
R3015537	93
R3015541	91
R3015542	62, 71
R3015543	93, 99
R3015611	62, 73
R3015613	93, 99
R3015671	91
R3015695	42
R3015702	40
R3015708	61, 73
R3015709	62, 75
R3015711	61, 73
R3015724	46
R3016054	62, 71
R3016055	62, 71
R3016058	61, 71
R3016059	61, 71
R3016075	62, 74
R3016078	41
R3016091	88
R3016092	89
R3016094	91
R3016097	86
R3016098	61, 75
R3016099	62, 75
R3016107	23
R3016118	62, 75
R3016122	10, 23, 89
R3016153	87, 98
R3016163	99
R3016163	93
R3016167	87, 98
R3016184	49, 55
R3016197	49, 55
R3016198	49, 56
R3016222	62, 71
R3016223	62, 71
R3016227	41
R3016229	44
R3016232	41
R3016233	41
R3016236	86
R3016277	61, 71
R3016292	93, 99
R3016336	44
R3016354	43
R3016364	60, 72
R3016390	58, 66
R3016392	48, 51
R3016393	48, 51
R3016394	58, 66
R3016395	61, 73

PART NO.	PAGE NO.
R3016396	58, 66
R3016397	90
R3016399	45
R3016402	44
R3016407	109, 115
R3016416	93
R3016417	109, 115
R3016418	109, 115
R3016421	43
R3016435	41
R3016436	41
R3016466	91
R3016468	44
R3016477	49, 55
R3016492	49, 55
R3016493	40
R3016494	48, 54
R3016495	59, 68
R3016501	23, 87
R3016502	23, 90
R3016504	23, 86
R3016505	92
R3016507	48, 52
R3016508	48, 52
R3016519	23
R3016526	59, 66
R3016527	58, 66
R3016528	58, 66
R3016529	59, 66
R3016530	59, 66
R3016540	60, 76
R3016541	58, 68
R3016560	87
R3016561	87
R3016564	89
R3016565	87
R3016566	87
R3016567	88
R3016571	125
R3016576	45
R3016580	125
R3016586	125
R3016593	40
R3016598	41
R3016600	42
R3016607	89
R3016614	46
R3016616	45
R3016618	46
R3016619	45
R3016623	126
R3016636	91
R3016653	62, 71
R3016686	45
R3016775	86
R3016777	86

PART NO.	PAGE NO.
R3016818	61, 77
R3016819	59, 69
R3017088	107, 112
R3017089	107, 112
R3025199	90
R30401011	23
R30401754	23, 92
S-21448M-2	41
S-21464-M-2	42
S-21472-M-2	42
S-21488-M-2	42

Vehicle models, trademarks, brands, and names depicted herein are the property of their respective owners, and may not be associated with Meritor, Inc. or its affiliates.



Meritor Heavy Vehicle Systems, LLC
7975 Dixie Highway
Florence, Kentucky 41042 USA

888-725-9355 U.S.
800-387-3889 Canada
MeritorPartsXpress.com
meritor.com

©2019 Meritor, Inc.
Litho in USA, PB-9968-CMP
Issued 12-19 (87410)